

# SECTION **SBC**

## SEAT BELT CONTROL SYSTEM

A  
B  
C  
D  
E  
F  
G  
I  
J  
K  
L  
M  
N  
O  
P

### CONTENTS

<p><b>BASIC INSPECTION</b> ..... 3</p> <p><b>DIAGNOSIS AND REPAIR WORK FLOW</b> ..... 3</p> <p style="padding-left: 20px;">Work Flow .....3</p> <p><b>SYSTEM DESCRIPTION</b> ..... 6</p> <p><b>PRE-CRASH SEAT BELT SYSTEM</b> ..... 6</p> <p style="padding-left: 20px;">System Diagram .....6</p> <p style="padding-left: 20px;">System Description .....6</p> <p style="padding-left: 20px;">Component Parts Location .....7</p> <p style="padding-left: 20px;">Component Description .....7</p> <p><b>SEAT BELT WARNING SYSTEM</b> ..... 9</p> <p style="padding-left: 20px;">System Diagram .....9</p> <p style="padding-left: 20px;">System Description .....9</p> <p style="padding-left: 20px;">Component Parts Location .....10</p> <p style="padding-left: 20px;">Component Description .....10</p> <p><b>ON BOARD DIAGNOSTIC (OBD) SYSTEM</b> .....12</p> <p style="padding-left: 20px;">Diagnosis Description .....12</p> <p><b>DIAGNOSIS SYSTEM (PRE-CRASH SEAT BELT)</b> .....14</p> <p style="padding-left: 20px;">CONSULT-III Function .....14</p> <p><b>DTC/CIRCUIT DIAGNOSIS</b> .....15</p> <p><b>U1000 CAN COMM CIRCUIT</b> .....15</p> <p style="padding-left: 20px;">Description .....15</p> <p style="padding-left: 20px;">DTC Logic .....15</p> <p style="padding-left: 20px;">Diagnosis Procedure .....15</p> <p><b>B2451 SB MOTOR RH CIRC</b> .....16</p> <p style="padding-left: 20px;">Description .....16</p> <p style="padding-left: 20px;">DTC Logic .....16</p> <p style="padding-left: 20px;">Diagnosis Procedure .....16</p> <p><b>B2452 SB MOTOR LH CIRC</b> .....17</p> <p style="padding-left: 20px;">Description .....17</p> <p style="padding-left: 20px;">DTC Logic .....17</p> <p style="padding-left: 20px;">Diagnosis Procedure .....17</p>	<p><b>B2453 BR STROKE SEN CIRC</b> .....18</p> <p style="padding-left: 20px;">Description .....18</p> <p style="padding-left: 20px;">DTC Logic .....18</p> <p style="padding-left: 20px;">Diagnosis Procedure .....18</p> <p style="padding-left: 20px;">Component Inspection .....19</p> <p><b>B2454 MOTOR PWR SUP CIRC</b> .....21</p> <p style="padding-left: 20px;">Description .....21</p> <p style="padding-left: 20px;">DTC Logic .....21</p> <p style="padding-left: 20px;">Diagnosis Procedure .....21</p> <p><b>B2455 PSB C/U INT CIRCUIT</b> .....22</p> <p style="padding-left: 20px;">Description .....22</p> <p style="padding-left: 20px;">DTC Logic .....22</p> <p style="padding-left: 20px;">Diagnosis Procedure .....22</p> <p><b>SEAT BELT BUCKLE SWITCH</b> .....23</p> <p><b>DRIVER SIDE</b> .....23</p> <p style="padding-left: 20px;">DRIVER SIDE : Description .....23</p> <p style="padding-left: 20px;">DRIVER SIDE : Component Function Check .....23</p> <p style="padding-left: 20px;">DRIVER SIDE : Diagnosis Procedure .....23</p> <p style="padding-left: 20px;">DRIVER SIDE : Component Inspection .....24</p> <p><b>PASSENGER SIDE</b> .....24</p> <p style="padding-left: 20px;">PASSENGER SIDE : Description .....24</p> <p style="padding-left: 20px;">PASSENGER SIDE : Component Function Check .....24</p> <p style="padding-left: 20px;">PASSENGER SIDE : Diagnosis Procedure .....25</p> <p style="padding-left: 20px;">PASSENGER SIDE : Component Inspection .....26</p> <p><b>POWER SUPPLY AND GROUND CIRCUIT</b> .....27</p> <p style="padding-left: 20px;">Diagnosis Procedure .....27</p> <p><b>SEAT BELT WARNING LAMP CIRCUIT</b> .....28</p> <p style="padding-left: 20px;">Diagnosis Procedure .....28</p> <p><b>SEAT BELT WARNING SYSTEM</b> .....29</p> <p style="padding-left: 20px;">Wiring Diagram - SEAT BELT WARNING SYS-TEM - .....29</p> <p><b>ECU DIAGNOSIS INFORMATION</b> .....34</p>
---	---

SBC

<b>PRE-CRASH SEAT BELT CONTROL UNIT ....</b>	<b>34</b>	DRIVER SIDE : Diagnosis Procedure .....	57
Reference Value .....	34	<b>PASSENGER SIDE .....</b>	<b>57</b>
Fail Safe .....	35	PASSENGER SIDE : Diagnosis Procedure .....	57
DTC Index .....	35	<b>PRECAUTION .....</b>	<b>58</b>
Wiring Diagram - PRE-CRASH SEAT BELT SYS-		<b>PRECAUTIONS .....</b>	<b>58</b>
TEM - .....	36	Precaution for Supplemental Restraint System	
<b>DIAGNOSIS SENSOR UNIT .....</b>	<b>42</b>	(SRS) "AIR BAG" and "SEAT BELT PRE-TEN-	
DTC Index .....	42	SIONER" .....	58
Wiring Diagram - SRS AIR BAG CONTROL SYS-		Service Procedure Precautions for Models with a	
TEM - .....	46	Pop-up Roll Bar .....	58
<b>SYMPTOM DIAGNOSIS .....</b>	<b>55</b>	Precaution for Battery Service .....	58
<b>SEAT BELT WARNING LAMP DOES NOT</b>		<b>PERIODIC MAINTENANCE .....</b>	<b>59</b>
<b>TURN OFF .....</b>	<b>55</b>	<b>PRE-INSPECTION FOR DIAGNOSTIC .....</b>	<b>59</b>
Diagnosis Procedure .....	55	Description .....	59
<b>SEAT BELT WARNING LAMP DOES NOT</b>		<b>REMOVAL AND INSTALLATION .....</b>	<b>60</b>
<b>TURN ON .....</b>	<b>56</b>	<b>BRAKE PEDAL STROKE SENSOR .....</b>	<b>60</b>
Diagnosis Procedure .....	56	Exploded View .....	60
<b>PRE-CRASH SEAT BELT DOES NOT OPER-</b>		Removal and Installation .....	60
<b>ATE .....</b>	<b>57</b>	<b>PRE-CRASH SEAT BELT CONTROL UNIT ....</b>	<b>61</b>
<b>BOTH SIDES .....</b>	<b>57</b>	Exploded View .....	61
BOTH SIDES : Diagnosis Procedure .....	57	Removal and Installation .....	61
<b>DRIVER SIDE .....</b>	<b>57</b>		

# DIAGNOSIS AND REPAIR WORK FLOW

< BASIC INSPECTION >

## BASIC INSPECTION

### DIAGNOSIS AND REPAIR WORK FLOW

Work Flow

INFOID:000000006471688

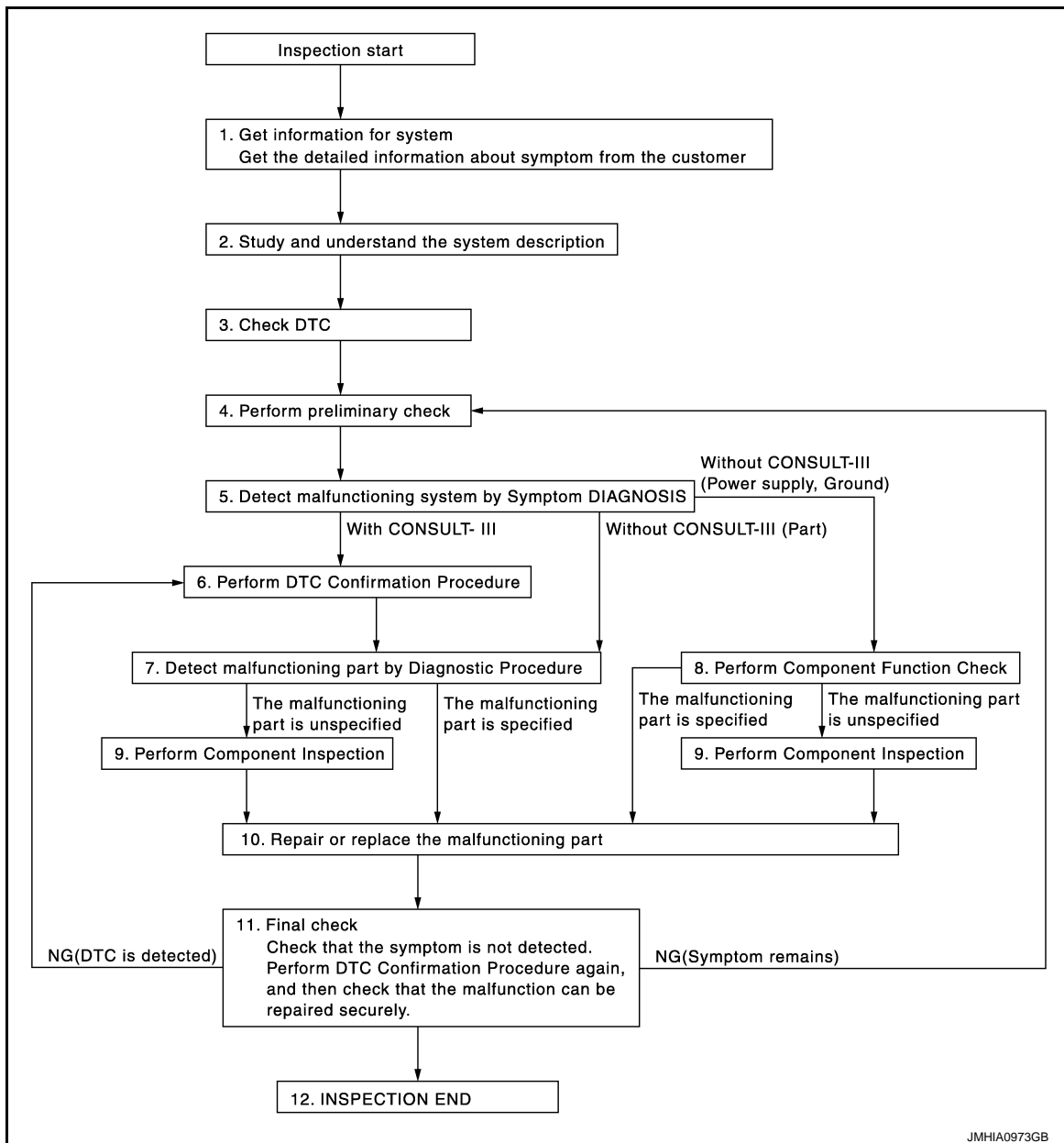

#### 1. GET INFORMATION FOR SYSTEM

Interview the customer to obtain the malfunction information (conditions and environment when the malfunction occurred) as much as possible when the customer brings the vehicles in.

>> GO TO 2.

#### 2. STUDY AND UNDERSTAND THE SYSTEM DESCRIPTION

Understand the operation condition or non-operation condition of pre-crash seat belt. Refer to [SBC-6. "System Description"](#).

>> GO TO 3.

# DIAGNOSIS AND REPAIR WORK FLOW

< BASIC INSPECTION >

---

## 3. CHECK DTC

---

Perform "Self-diagnosis procedure" of appropriate DTC to check if DTC is detected again.

At this time, always connect CONSULT-III to the vehicle, and then check the diagnosis results in real time on "DATA MONITOR (AUTO RECORD)".

There is no priority for each DTC. Record them based on the following rules.

Current malfunction: Record all DTCs detected.

Past malfunction: Record up to 5 DTCs. When the 6th DTC is detected, it is overwritten to the last recorded DTC.

Is DTC detected?

YES >> GO TO 4.

NO >> Follow the diagnosis simulation test to check. Refer to [GI-43, "Intermittent Incident"](#).

## 4. PERFORM PRELIMINARY CHECK

---

Perform preliminary check. Refer to [SBC-57, "BOTH SIDES : Diagnosis Procedure"](#).

>> GO TO 5.

## 5. DETECT MALFUNCTIONING SYSTEM BY SYMPTOM DIAGNOSIS

---

Identify the malfunctioning system with "Malfunctioning system by symptom diagnosis". Refer to [SBC-57, "BOTH SIDES : Diagnosis Procedure"](#).

With CONSULT-III >> GO TO 6.

Without CONSULT-III >> GO TO 7 (Parts system).

Without CONSULT-III >> GO TO 8 (Power supply, ground system).

## 6. PERFORM DTC CONFIRMATION PROCEDURE

---

Perform the inspection with "DTC CONFIRMATION PROCEDURE" of the applicable system.

>> GO TO 7.

## 7. DETECT MALFUNCTIONING PART BY DIAGNOSTIC PROCEDURE

---

Identify the malfunctioning part with "Diagnosis Procedure".

Are malfunctioning parts detected?

YES >> GO TO 10.

NO >> GO TO 9.

## 8. PERFORM COMPONENT FUNCTION CHECK

---

Identify the malfunctioning part with "Component Function Check".

Are malfunctioning parts detected?

YES >> GO TO 10.

NO >> GO TO 9.

## 9. PERFORM COMPONENT INSPECTION

---

Perform the inspection with "Component Inspection".

>> GO TO 10.

## 10. REPAIR OR REPLACE THE MALFUNCTIONING PART

---

Repair or replace the specified malfunctioning parts.

After repairing or replacing, reconnect parts or connector disconnected in "Diagnosis Procedure", and then erase DTC if necessary. Refer to [SBC-14, "CONSULT-III Function"](#).

>> GO TO 11.

## 11. FINAL CHECK

---

Perform "CONSULT-III function" again to check that the repair is performed correctly.

## DIAGNOSIS AND REPAIR WORK FLOW

### < BASIC INSPECTION >

---

Check that malfunctions are not reproduced when obtaining the malfunction information from the customer, referring to the symptom inspection result in step 4.

#### Are all malfunctions corrected?

YES >> • Before delivering the vehicle to the customer, check that that DTC is erased.  
• INSPECTION END

NO >> DTC is reproduced: GO TO 6.

A

B

C

D

E

F

G

SBC

I

J

K

L

M

N

O

P

# PRE-CRASH SEAT BELT SYSTEM

< SYSTEM DESCRIPTION >

## SYSTEM DESCRIPTION

### PRE-CRASH SEAT BELT SYSTEM

#### System Diagram

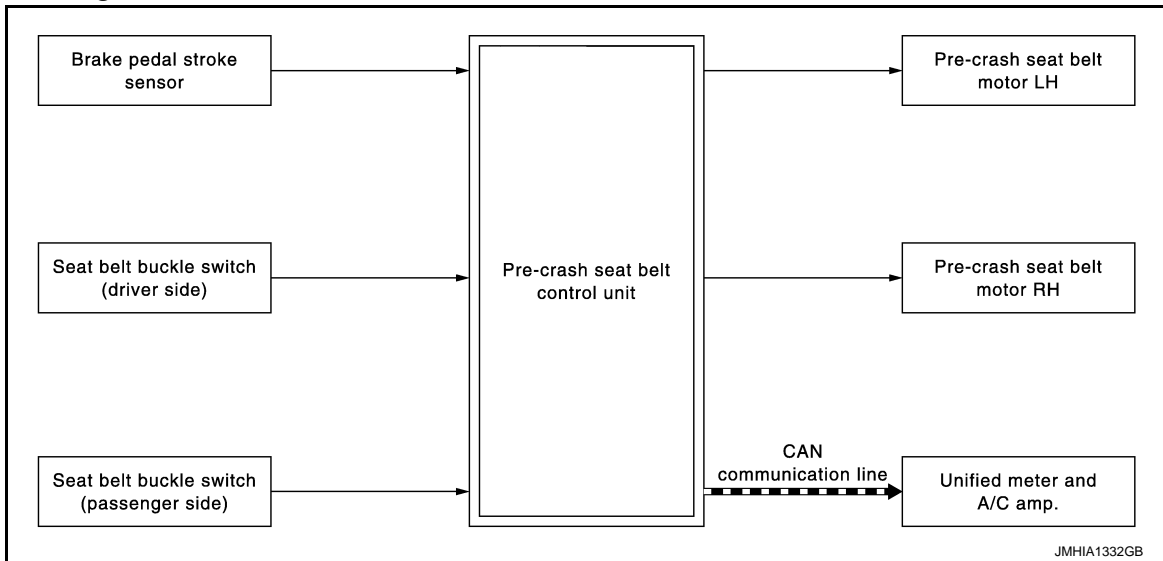

#### System Description

INFOID:000000006471690

- Pre-crash seat belt is adopted to RH/LH seat belts.
- Pre-crash seat belt retracts shoulder webbing by a motor in pre-tensioner seat belt.
- Facilitates an emergency operation by restraining change in occupant posture while emergency braking is being applied.
- Restrains occupant faster and firmly, maximizes the effect of other devices like air bag, and reduces possible damage if a collision is unavoidable.
- Provides occupant a sense of ease by pulling occupants body to seat during braking that does not result a collision.

#### FUNCTION DESCRIPTION

Pre-crash seat belt is activated in the conditions as per the following.  
Emergency braking is applied.

#### OPERATION CONDITION

The activation and deactivation conditions of pre-crash seat belt are as per the following.

	Activating condition	Deactivating condition
Emergency braking is applied	<ul style="list-style-type: none"> <li>• Judges that emergency braking is applied</li> <li>• Vehicle speed is 15 km/h (9 MPH) or more</li> </ul>	<ul style="list-style-type: none"> <li>• When the vehicle accelerates</li> <li>• The vehicle stays stopped</li> </ul>

#### OPERATION PROHIBITION CONDITION

- Seat belt is not fastened (Only the seat belt that is not fastened does not operate).
- At fail-safe condition.

# PRE-CRASH SEAT BELT SYSTEM

< SYSTEM DESCRIPTION >

## Component Parts Location

INFOID:000000006471691

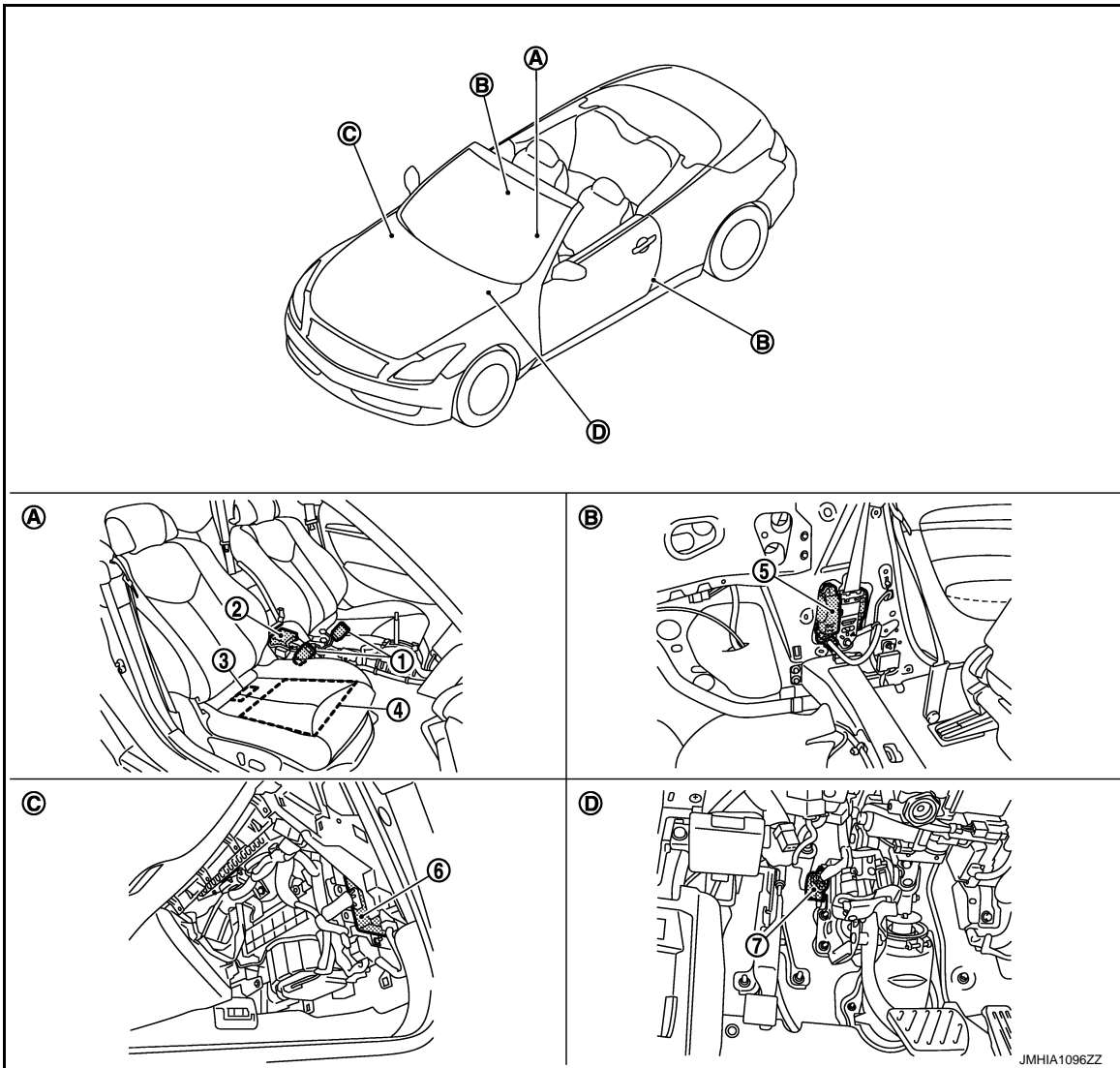

- |  |   |   |
|--|---|---|
| 1. Seat belt buckle switch<br>Driver side: B13<br>Passenger side: B213 | 2. Air bag diagnosis sensor unit E36                | 3. Occupant Classification System control unit B214 |
| 4. Occupant Classification System seat sensor mat                      | 5. Pre-crash seat belt motor<br>LH: B28<br>RH: B228 | 6. Pre-crash seat belt control unit M110            |
| 7. Brake pedal stroke sensor E116                                      |   |   |
| A. Front seat  | B. Behind rear side finisher                        | C. Behind glove box assembly                        |
| D. Behind instrument driver lower cover                                |   |   |

## Component Description

INFOID:000000006471692

Component	Function
Pre-crash seat belt control unit	It controls pre-crash seat belt motor according to input signal.
Pre-crash seat belt motor (Seat belt motor [RH/LH])	It is built into seat belt retractor, and it pulls, returns, and maintains according to the motor rotation.

A  
B  
C  
D  
E  
F  
G  
SBC  
I  
J  
K  
L  
M  
N  
O  
P

## PRE-CRASH SEAT BELT SYSTEM

### < SYSTEM DESCRIPTION >

Component	Function
Brake pedal stroke sensor	<ul style="list-style-type: none"><li>• It changes voltage according to brake pedal depressed amount and sends the signal to pre-crash seat belt control unit.</li><li>• There are 2 signals (brake pedal stroke sensor 1 and 2) sent from the brake pedal stroke sensor. Pre-crash seat belt control unit will judge the stroke amount and the speed of the brake pedal according to the voltage of the signal sent by each side.</li></ul>
Seat belt buckle switch	It is arranged in the seat belt buckle and judges whether the seat belt is fastened or not fastened.
Unified meter and A/C amp	It transmits the vehicle status to pre-crash seat belt control unit using the CAN communication system.
Combination meter (Seat belt warning lamp)	It indicates a malfunction of pre-crash seat belt system.



# SEAT BELT WARNING SYSTEM

< SYSTEM DESCRIPTION >

## SEAT BELT WARNING SYSTEM

### System Diagram

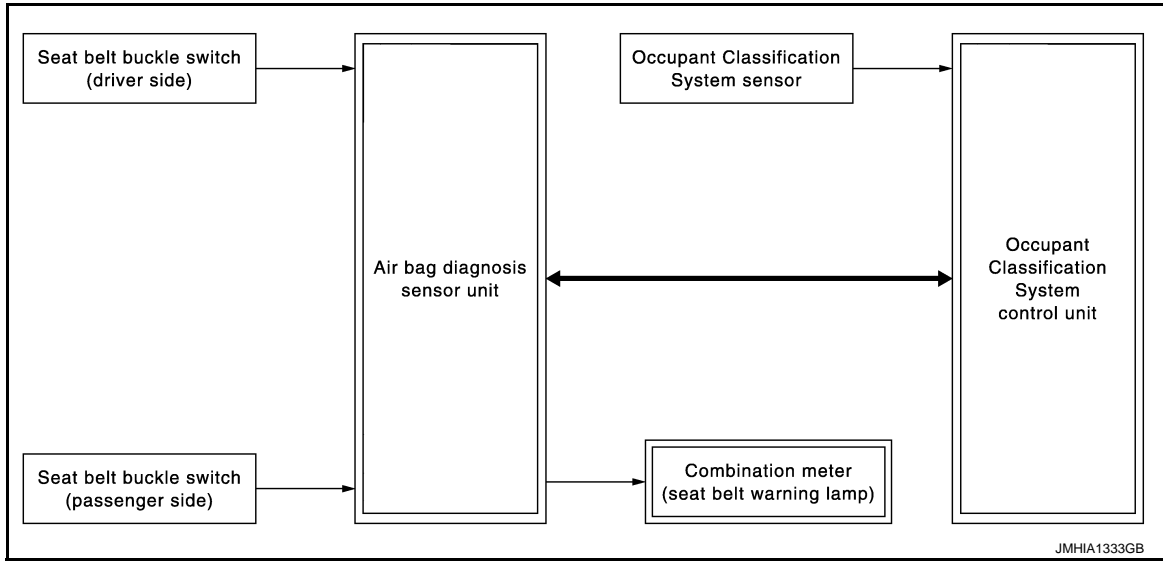

### System Description

INFOID:000000006471694

- Turns ON seat belt warning lamp, when the Occupant Classification System judges adult or child in the front passenger seat and the passenger seat belt buckle switch is OFF.
- Operation of air bag diagnosis sensor unit when air bag diagnosis sensor unit receives information from Occupant Classification System.
- In addition, seat belt warning lamp illuminates, when the driver side seat belt is not fasten. This does not relate to the air bag diagnosis sensor unit.

SBC

Status (front passenger seat)	Seat belt warning lamp (When front passenger seat is unbuckled)
Empty	OFF
An object	OFF
Child/ child-seat	ON
Adult	ON
Malfunction	OFF

# SEAT BELT WARNING SYSTEM

< SYSTEM DESCRIPTION >

## Component Parts Location

INFOID:000000006471695

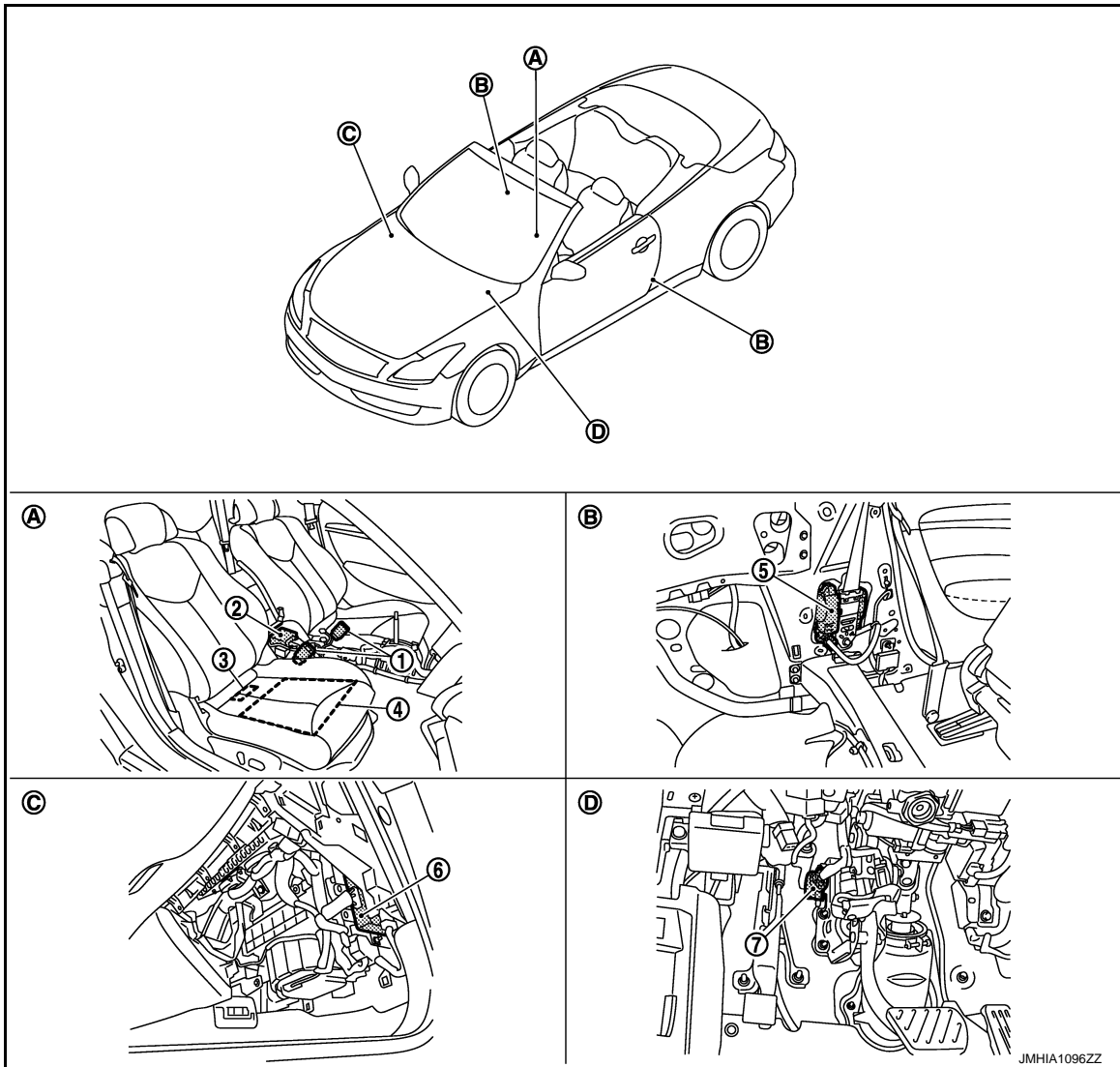

- |  |   |   |
|--|---|---|
| 1. Seat belt buckle switch<br>Driver side: B13<br>Passenger side: B213 | 2. Air bag diagnosis sensor unit E36                | 3. Occupant Classification System control unit B214 |
| 4. Occupant Classification System seat sensor mat                      | 5. Pre-crash seat belt motor<br>LH: B28<br>RH: B228 | 6. Pre-crash seat belt control unit M110            |
| 7. Brake pedal stroke sensor E116                                      |   |   |
| A. Front seat  | B. Behind rear side finisher                        | C. Behind glove box assembly                        |
| D. Behind instrument driver lower cover                                |   |   |

## Component Description

INFOID:000000006471696

Component parts	Outline of function
Seat belt buckle switch (Driver side)	Detects if the seat belt buckle switch (driver side) is fastened or unfastened
Seat belt buckle switch (Passenger side)	Detects if the seat belt buckle switch (passenger side) is fastened or unfastened
Combination meter (Seat belt warning lamp)	Turns the seat belt warning lamp ON when the seat belt is unfastened
Occupant Classification System control unit	Judges the passenger seat condition based on the information from Occupant Classification System control unit

# SEAT BELT WARNING SYSTEM

## < SYSTEM DESCRIPTION >

Component parts	Outline of function
Occupant Classification System seat sensor	Detects if the passenger seat is empty or occupied
Air bag diagnosis sensor unit	Turns ON seat belt warning lamp based on the information from Occupant Classification System control unit
Front passenger air bag OFF indicator	Turns the front passenger air bag OFF indicator lamp ON when the front passenger seat is occupied by a child or a child seat

A

B

C

D

E

F

G

**SBC**

I

J

K

L

M

N

O

P

# ON BOARD DIAGNOSTIC (OBD) SYSTEM

< SYSTEM DESCRIPTION >

## ON BOARD DIAGNOSTIC (OBD) SYSTEM

### Diagnosis Description

INFOID:000000006471697

#### DIAGNOSIS FUNCTION

When pre-crash seat belt control unit detects a malfunction, seat belt warning lamp blinks or turn ON and warns the user of the malfunction.

#### How to Read Seat Belt Warning Lamp

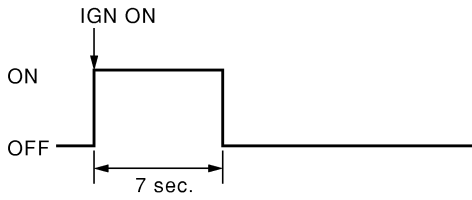
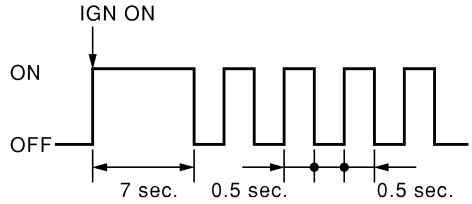

1. Turn the ignition switch from OFF to ON, and check that the seat belt warning lamp blinks.
2. Compare the seat belt warning lamp blinking pattern with the examples.

#### Seat Belt Warning Lamp Examples

Seat belt warning lamp operation	Condition	Reference item
 <p>SHIA0011E</p>	No malfunction is detected	—
 <p>SHIA0012E</p>	Pre-crash seat belt system is malfunctioning	Check "CAUSE OF WARNING" in "Special Function" with CONSULT-III. Refer to <a href="#">SRC-21, "CONSULT-III Function"</a>

# ON BOARD DIAGNOSTIC (OBD) SYSTEM

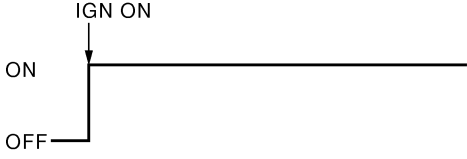
## < SYSTEM DESCRIPTION >

Seat belt warning lamp operation	Condition	Reference item
 <p style="text-align: right; margin-right: 50px;">SHIA0013E</p>	<p>Seat belt is not fastened</p>	<p>—</p>
 <p style="text-align: right; margin-right: 50px;">SHIA0014E</p>	<ul style="list-style-type: none"> <li>Pre-crash seat belt control unit is malfunctioning</li> <li>Seat belt warning lamp circuit is malfunctioning</li> </ul>	<p>Refer to <a href="#">SBC-28, "Diagnosis Procedure"</a></p>

A  
B  
C  
D  
E  
F  
G  
I  
J  
K  
L  
M  
N  
O  
P

SBC

## DIAGNOSIS SYSTEM (PRE-CRASH SEAT BELT)

< SYSTEM DESCRIPTION >

### DIAGNOSIS SYSTEM (PRE-CRASH SEAT BELT)

#### CONSULT-III Function

INFOID:000000006471698

Diagnosis for pre-crash seat belt system can be performed using CONSULT-III.

#### APPLICATION ITEM

Diagnosis Mode	Function description
Self-diagnosis Results	<ul style="list-style-type: none"><li>• Displays data recorded when a malfunction is detected.</li><li>• Can print out the display.</li><li>• Erases DTC recorded in memory.</li></ul>
Data Monitor	Displays input data for pre-crash seat belt control unit in real time.
CAN DIAG SUPPORT MNTR	Monitors communication status of CAN communication.
ECU PART NUMBER	Displays pre-crash seat belt control unit part number.

#### DATA MONITOR

Monitor item	[Operation or unit]	Display item
SB SW RH SIG	[ON/OFF]	ON/OFF status of RH seat belt switch signal is displayed.
SB SW LH SIG	[ON/OFF]	ON/OFF status of LH seat belt switch signal is displayed.
VHCL SPEED SE	[km/h]	Vehicle speed signal is displayed.
B PEDAL SIG1	[V]	Brake pedal stroke sensor 1 signal voltage is displayed.
B PEDAL SIG2	[V]	Brake pedal stroke sensor 2 signal voltage is displayed.

# U1000 CAN COMM CIRCUIT

< DTC/CIRCUIT DIAGNOSIS >

## DTC/CIRCUIT DIAGNOSIS

### U1000 CAN COMM CIRCUIT

#### Description

INFOID:000000006471699

CAN (Controller Area Network) is a serial communication line for real time applications. It is an on-vehicle multiplex communication line with high data communication speed and excellent error detection ability. Modern vehicle is equipped with many electronic control unit, and each control unit shares information and links with other control units during operation (not independent). In CAN communication, control units are connected with 2 communication lines (CAN H-line, CAN L-line) allowing a high rate of information transmission with less wiring. Each control unit transmits/receives data but selectively reads required data only.

CAN Communication Signal Chart. Refer to [LAN-23, "CAN Communication Signal Chart"](#).

#### DTC Logic

INFOID:000000006471700

#### DTC DETECTION LOGIC

DTC	CONSULT-III display description	DTC Detection Condition	Possible cause
U1000	CAN COMM CIRCUIT	When pre-crash seat belt control unit cannot communicate CAN communication signal continuously for 2 seconds or more.	CAN communication system

#### Diagnosis Procedure

INFOID:000000006471701

#### 1. PERFORM SELF DIAGNOSTIC

1. Turn ignition switch ON and wait for 2 seconds or more.
2. Check "Self Diagnostic Result".

Is DTC "U1000" displayed?

- YES >> Refer to [LAN-14, "Trouble Diagnosis Flow Chart"](#).  
NO >> Refer to [GI-43, "Intermittent Incident"](#).

# B2451 SB MOTOR RH CIRC

< DTC/CIRCUIT DIAGNOSIS >

## B2451 SB MOTOR RH CIRC

### Description

INFOID:000000006471702

- It pulls, returns, and maintains according to the motor rotation.
- It is built into the seat belt retractor.

### DTC Logic

INFOID:000000006471703

### DTC DETECTION LOGIC

DTC No.	Self-diagnosis item	DTC Detection Condition	Possible causes
B2451	Seat belt motor system RH	Circuit of seat belt motor (RH) is open or shorted	<ul style="list-style-type: none"><li>• Open circuit, short circuit to battery, and short circuit to ground in seat belt motor (RH) harness</li><li>• Pre-crash seat belt control unit</li></ul>

### DTC CONFIRMATION PROCEDURE

#### 1. SELF-DIAGNOSIS WITH PRE-CRASH SEAT BELT MOTOR RH CIRCUIT

1. Turn ignition switch ON.
2. Check "Self-diagnostic result" with CONSULT-III.

#### Is DTC detected?

- YES >> Refer to [SBC-16, "Diagnosis Procedure"](#).  
NO >> Pre-crash seat belt motor RH system is normal.

### Diagnosis Procedure

INFOID:000000006471704

#### 1. CHECK PRE-CRASH SEAT BELT MOTOR RH CIRCUIT

1. Turn ignition switch OFF.
2. Disconnect pre-crash seat belt control unit connector and pre-crash seat belt motor RH connector.
3. Check continuity between pre-crash seat belt control unit harness connector and pre-crash seat belt motor RH harness connector.

Pre-crash seat belt control unit		Pre-crash seat belt motor RH		Continuity
Connector	Terminal	Connector	Terminal	
M110	1	B228	1	Existed
	3		2	

4. Check continuity between pre-crash seat belt control unit harness connector and ground.

Pre-crash seat belt control unit		Ground	Continuity
Connector	Terminal		
M110	1		Not existed
	3		

#### Is the inspection result normal?

- YES >> GO TO 2.  
NO >> Repair or replace harness.

#### 2. SELF-DIAGNOSIS WITH PRE-CRASH SEAT BELT MOTOR RH CIRCUIT

1. Replace pre-crash seat belt motor RH.
2. Connect pre-crash seat belt control unit connector and pre-crash seat belt motor RH connector.
3. Turn ignition switch ON.
4. Check "Self-diagnostic result" with CONSULT-III.

#### Is DTC detected?

- YES >> Replace pre-crash seat belt control unit.  
NO >> INSPECTION END



# B2452 SB MOTOR LH CIRC

< DTC/CIRCUIT DIAGNOSIS >

## B2452 SB MOTOR LH CIRC

### Description

INFOID:000000006471705

- It pulls, returns, and maintains according to the motor rotation.
- It is built into the seat belt retractor.

### DTC Logic

INFOID:000000006471706

### DTC DETECTION LOGIC

DTC No.	Self-diagnosis item	DTC Detection Condition	Possible causes
B2452	Seat belt motor system LH	Circuit of seat belt motor (LH) is open or shorted	<ul style="list-style-type: none"><li>• Open circuit, short circuit to battery, and short circuit to ground in seat belt motor (LH) harness</li><li>• Pre-crash seat belt control unit</li></ul>

### DTC REPRODUCTION PROCEDURE

#### 1. SELF-DIAGNOSIS WITH PRE-CRASH SEAT BELT MOTOR LH CIRCUIT

1. Turn ignition switch ON.
2. Check "Self-diagnostic result" with CONSULT-III.

Is DTC detected?

- YES >> Refer to [SBC-17, "Diagnosis Procedure"](#).  
NO >> Pre-crash seat belt motor LH system is normal.

### Diagnosis Procedure

INFOID:000000006471707

#### 1. CHECK PRE-CRASH SEAT BELT MOTOR LH CIRCUIT

1. Turn ignition switch OFF.
2. Disconnect pre-crash seat belt control unit connector and pre-crash seat belt motor LH connector.
3. Check continuity between pre-crash seat belt control unit harness connector and pre-crash seat belt motor LH harness connector.

Pre-crash seat belt control unit		Pre-crash seat belt motor LH		Continuity
Connector	Terminal	Connector	Terminal	
M110	4	B28	2	Existed
	6		1	

4. Check continuity between pre-crash seat belt control unit harness connector and ground.

Pre-crash seat belt control unit		Ground	Continuity
Connector	Terminal		
M110	4		Not existed
	6		

Is the inspection result normal?

- YES >> GO TO 2.  
NO >> Repair or replace harness.

#### 2. SELF-DIAGNOSIS WITH PRE-CRASH SEAT BELT MOTOR LH CIRCUIT

1. Replace pre-crash seat belt motor LH.
2. Connect pre-crash seat belt control unit connector and pre-crash seat belt motor LH connector.
3. Turn ignition switch ON.
4. Check "Self-diagnostic result" with CONSULT-III.

Is DTC detected?

- YES >> Replace pre-crash seat belt control unit.  
NO >> INSPECTION END

A  
B  
C  
D  
E  
F  
G  
I  
J  
K  
L  
M  
N  
O  
P

SBC

# B2453 BR STROKE SEN CIRC

< DTC/CIRCUIT DIAGNOSIS >

## B2453 BR STROKE SEN CIRC

### Description

INFOID:000000006471708

- It changes voltage according to brake pedal depressed amount and sends the signal to pre-crash seat belt control unit.
- There are 2 signals (brake pedal stroke sensor 1 and 2) sent from the brake pedal stroke sensor. Pre-crash seat belt control unit judges the stroke amount and the speed of the brake pedal according to the voltage of the signal sent by each side.

### DTC Logic

INFOID:000000006471709

### DTC DETECTION LOGIC

DTC No.	Self-diagnosis item	DTC Detection Condition	Possible causes
B2453	BR STROKE SEN CIRC	Circuit of brake pedal stroke sensor output is open or shorted	<ul style="list-style-type: none"><li>• Open circuit, short circuit to battery, and short circuit to ground in brake pedal stroke sensor harness</li><li>• Pre-crash seat belt control unit</li><li>• Brake pedal stroke sensor</li></ul>

### DTC CONFIRMATION PROCEDURE

#### 1. SELF-DIAGNOSIS WITH PRE-CRASH SEAT BELT CONTROL UNIT

1. Turn ignition switch ON.
2. Check "Self-diagnostic result" with CONSULT-III.

#### Is DTC detected?

- YES >> Refer to [SBC-18, "Diagnosis Procedure"](#).  
NO >> INSPECTION END

### Diagnosis Procedure

INFOID:000000006471710

#### 1. CHECK PRE-CRASH SEAT BELT CONTROL UNIT INPUT SIGNAL

1. Turn ignition switch ON.
2. Select "B PEDAL SIG1" and "B PEDAL SIG2" in "DATA MONITOR" mode with CONSULT-III.
3. Check "B PEDAL SIG1" and "B PEDAL SIG2" indication under the following conditions.

Monitor item	Condition	Voltage (V) (Approx.)
B PEDAL SIG1	Brake released → depressed	1 → 4
B PEDAL SIG2		4 → 1

#### Is the inspection result normal?

- YES >> GO TO 5.  
NO >> GO TO 2.

#### 2. CHECK BRAKE PEDAL STROKE SENSOR POWER SUPPLY

1. Turn ignition switch OFF.
2. Disconnect brake pedal stroke sensor connector.
3. Check voltage between brake pedal stroke sensor harness connector and ground.

Brake pedal stroke sensor		Ground	Voltage (V) (Approx.)
Connector	Terminal		
E116	2		5

#### Is the inspection result normal?

- YES >> GO TO 3.  
NO >> GO TO 4.

# B2453 BR STROKE SEN CIRC

< DTC/CIRCUIT DIAGNOSIS >

## 3.CHECK BRAKE PEDAL STROKE SENSOR CIRCUIT

1. Disconnect pre-crash seat belt control unit connector.
2. Check continuity between pre-crash seat belt control unit harness connector and brake pedal stroke sensor harness connector.

Pre-crash seat belt control unit		Brake pedal stroke sensor		Continuity
Connector	Terminal	Connector	Terminal	
M110	16	E116	1	Existed
	20		3	
	21		4	

3. Check continuity between pre-crash seat belt control unit harness connector and ground.

Pre-crash seat belt control unit		Ground	Continuity
Connector	Terminal		
M110	16		Not existed
	20		
	21		

Is the inspection result normal?

YES >> Refer to [SBC-19, "Component Inspection"](#).

NO >> Repair or replace harness between pre-crash seat belt control unit and brake pedal stroke sensor.

## 4.CHECK BRAKE PEDAL STROKE SENSOR POWER SUPPLY CIRCUIT

1. Disconnect pre-crash seat belt control unit connector.
2. Check continuity between pre-crash seat belt control unit harness connector and brake pedal stroke sensor harness connector.

Pre-crash seat belt control unit		Brake pedal stroke sensor		Continuity
Connector	Terminal	Connector	Terminal	
M110	18	E116	2	Existed

3. Check continuity between pre-crash seat belt control unit and ground.

Pre-crash seat belt control unit		Ground	Continuity
Connector	Terminal		
M110	18		Not existed

Is the inspection result normal?

YES >> Replace pre-crash seat belt control unit. Refer to [SBC-61, "Removal and Installation"](#).

NO >> Repair or replace harness between pre-crash seat belt control unit and brake pedal stroke sensor.

## 5.CHECK INTERMITTENT INCIDENT

Refer to [GI-43, "Intermittent Incident"](#).

>> INSPECTION END

## Component Inspection

INFOID:000000006471711

## 1.CHECK BRAKE PEDAL STROKE SENSOR

1. Turn ignition switch OFF.
2. Disconnect brake pedal stroke sensor connector.
3. Check that continuity between brake pedal stroke sensor when performing the brake operation.

## B2453 BR STROKE SEN CIRC

### < DTC/CIRCUIT DIAGNOSIS >

Brake pedal stroke sensor		Condition	Resistance (K $\Omega$ ) (Approx.)
Terminal			
2	1	Brake released → depressed	1.0 → 0.2
	3		0.2 → 1.0

#### Is the inspection result normal?

YES >> Brake pedal stroke sensor system is normal.

NO >> Replace brake pedal stroke sensor. Refer to [SBC-60, "Removal and Installation"](#).

# B2454 MOTOR PWR SUP CIRC

< DTC/CIRCUIT DIAGNOSIS >

## B2454 MOTOR PWR SUP CIRC

### Description

INFOID:000000006471712

- When control unit activates pre-crash seat belt system, it retracts the shoulder belt with the electric motor and reduces seat belt slack.
- Power supply is supplied constantly from battery power supply.

### DTC Logic

INFOID:000000006471713

### DTC DETECTION LOGIC

DTC No.	Self-diagnosis item	DTC Detection Condition	Possible causes
B2454	SEAT BLT PWR DR CIRC	Motor power supply circuit is open or shorted	<ul style="list-style-type: none"><li>• Open circuit and short circuit to ground in drive circuit power supply harness</li><li>• Pre-crash seat belt control unit</li></ul>

### DTC CONFIRMATION PROCEDURE

#### 1.SELF-DIAGNOSIS WITH PRE-CRASH SEAT BELT CONTROL UNIT

1. Turn ignition switch ON.
2. Check "Self-diagnostic result" with CONSULT-III.

Is DTC detected?

- YES >> Refer to [SBC-21. "Diagnosis Procedure"](#).  
NO >> INSPECTION END

### Diagnosis Procedure

INFOID:000000006471714

#### 1.CHECK FUSE AND FUSIBLE LINK

Check that the following fuse and fusible link are not blown.

Terminal No.	Signal name	Fuse and fusible link No.
2	Battery power supply	G

Is the inspection result normal?

- YES >> GO TO 2.  
NO >> Replace the blown fuse or fusible link after repairing the affected circuit if a fuse or fusible link is blown.

#### 2.CHECK PRE-CRASH SEAT BELT MOTOR POWER SUPPLY

1. Turn ignition switch OFF.
2. Disconnect pre-crash seat belt control unit connector.
3. Check voltage between pre-crash seat belt control unit harness connector and ground.

Pre-crash seat belt control unit		Ground	Voltage (V) (Approx.)
Connector	Terminal		Battery voltage
M110	2		

Is the inspection result normal?

- YES >> Replace pre-crash seat belt control unit. Refer to [SBC-61. "Removal and Installation"](#).  
NO >> Repair or replace harness between pre-crash seat belt control unit and fusible link.

# B2455 PSB C/U INT CIRCUIT

< DTC/CIRCUIT DIAGNOSIS >

## B2455 PSB C/U INT CIRCUIT

### Description

INFOID:000000006471715

- It controls pre-crash seat belt motor according to input signal.
- It consists of pre-crash seat belt control unit.

### DTC Logic

INFOID:000000006471716

### DTC DETECTION LOGIC

DTC No.	Self-diagnosis item	DTC Detection Condition	Possible causes
B2455	C/U internal circuit system	Pre-crash seat belt control unit internal circuit malfunction	Pre-crash seat belt control unit

### DTC CONFIRMATION PROCEDURE

#### 1.SELF-DIAGNOSIS WITH PRE-CRASH SEAT BELT CONTROL UNIT

1. Turn ignition switch ON.
2. Check "Self-diagnostic result" with CONSULT-III.

#### Is DTC detected?

- YES >> Refer to [SBC-22, "Diagnosis Procedure"](#).  
NO >> INSPECTION END

### Diagnosis Procedure

INFOID:000000006471717

#### 1..INSPECTION START

1. Check "Self-diagnostic result" with CONSULT-III.
2. Touch "ERASE".
3. Perform DTC Confirmation Procedure.  
See [SBC-22, "DTC Logic"](#).

#### Is DTC B2455 displayed again?

- YES >> Replace pre-crash seat belt control unit. Refer to [SBC-61, "Removal and Installation"](#).  
NO >> GO TO 2.

#### 2.CHECK INTERMITTENT INCIDENT

Refer to [GI-43, "Intermittent Incident"](#).

>> INSPECTION END

# SEAT BELT BUCKLE SWITCH

< DTC/CIRCUIT DIAGNOSIS >

## SEAT BELT BUCKLE SWITCH

### DRIVER SIDE

#### DRIVER SIDE : Description

INFOID:000000006471718

- Performs the control of tension reducer according to the seat belt buckle switch ON/OFF.
- Detects whether or not the seat belt is fastened when the ignition switch turns ON. If the seat belt is not fastened, illuminates the seat belt warning lamp on the combination meter.

#### DRIVER SIDE : Component Function Check

INFOID:000000006471719

### 1. CHECK PRE-CRASH SEAT BELT CONTROL UNIT INPUT SIGNAL

Ⓜ With CONSULT-III

When checking "SB SW LH SIG" on DATA MONITOR screen, check that ON/OFF display changes synchronized with the insertion operation to the seat belt buckle.

Monitor item	Condition
SB SW LH SIG	When driver side seat belt is not fastened: OFF
	When driver side seat belt is fastened: ON

Is the inspection result normal?

- YES >> Seat belt buckle switch (driver side) circuit is normal.  
 NO >> Refer to [SBC-23, "DRIVER SIDE : Diagnosis Procedure"](#).

#### DRIVER SIDE : Diagnosis Procedure

INFOID:000000006471720

SBC

### 1. CHECK PRE-CRASH SEAT BELT CONTROL UNIT INPUT SIGNAL

Check that voltage between seat belt buckle switch (driver side) and ground.

(+)		(-)	Condition	Voltage (V) (Approx.)
Seat belt buckle switch (driver side) Connector	Terminal			
B13	1	Ground	When driver side seat belt is not fastened	12
			When driver side seat belt is fastened	0

Is the inspection result normal?

- YES >> Seat belt buckle switch (driver side) circuit is normal.  
 NO >> GO TO 2.

### 2. CHECK SEAT BELT BUCKLE SWITCH (DRIVER SIDE) CIRCUIT

1. Turn ignition switch OFF.
2. Disconnect pre-crash seat belt control unit connector and seat belt buckle switch (driver side) connector.
3. Check continuity between pre-crash seat belt control unit and seat belt buckle switch (driver side).

Pre-crash seat belt control unit		Seat belt buckle switch (driver side)		Continuity
Connector	Terminal	Connector	Terminal	
M110	10	B13	1	Existed

4. Check continuity between pre-crash seat belt control unit and ground.

Pre-crash seat belt control unit		Ground	Continuity
Connector	Terminal		
M110	10		Not existed

Is the inspection result normal?

# SEAT BELT BUCKLE SWITCH

## < DTC/CIRCUIT DIAGNOSIS >

YES >> GO TO 3.

NO >> Repair or replace harness between pre-crash seat belt control unit and seat belt buckle switch (driver side).

### 3.CHECK SEAT BELT BUCKLE SWITCH GROUND CIRCUIT

Check continuity between seat belt buckle switch (driver side) and ground.

Seat belt buckle switch (driver side)		Ground	Continuity
Connector	Terminal		Existed
B13	2		

Is the inspection result normal?

YES >> GO TO 4.

NO >> Repair or replace harness between seat belt buckle switch and ground.

### 4.CHECK SEAT BELT BUCKLE SWITCH (DRIVER SIDE)

Check seat belt buckle switch (driver side). Refer to [SBC-24, "DRIVER SIDE : Component Inspection"](#).

Is the inspection result normal?

YES >> Replace pre-crash seat belt control unit. Refer to [SBC-61, "Removal and Installation"](#).

NO >> Replace seat belt buckle switch (driver side).

## DRIVER SIDE : Component Inspection

INFOID:000000006471721

### 1.CHECK SEAT BELT BUCKLE SWITCH (DRIVER SIDE)

1. Turn ignition switch OFF.
2. Disconnect seat belt buckle switch connector.
3. Check continuity of seat belt buckle (driver side).

Seat belt buckle switch (driver side)		Condition	Continuity
Terminal			
1	2	When driver side seat belt is not fastened	Not existed
		When driver side seat belt is fastened	Existed

Is the inspection result normal?

YES >> INSPECTION END

NO >> Replace seat belt buckle switch (driver side).

## PASSENGER SIDE

### PASSENGER SIDE : Description

INFOID:000000006471722

- Performs the control of tension reducer according to the seat belt buckle switch ON/OFF.
- Detects whether or not the seat belt is fastened when the ignition switch turns ON. If the seat belt switch is not fastened, illuminates the seat belt warning lamp on the combination meter.

### PASSENGER SIDE : Component Function Check

INFOID:000000006471723

### 1.CHECK PRE-CRASH SEAT BELT CONTROL UNIT INPUT SIGNAL

Ⓟ With CONSULT-III

When checking "SB SW RH SIG" on DATA MONITOR screen, check that ON/OFF display changes are synchronized with the insertion operation to the seat belt buckle.

Monitor item	Condition
SB SW RH SIG	When driver side seat belt is not fastened: OFF
	When driver side seat belt is fastened: ON

Is the inspection result normal?

YES >> Seat belt buckle switch (passenger side) circuit is normal.

NO >> Refer to [SBC-25, "PASSENGER SIDE : Diagnosis Procedure"](#).



# SEAT BELT BUCKLE SWITCH

< DTC/CIRCUIT DIAGNOSIS >

## PASSENGER SIDE : Diagnosis Procedure

INFOID:000000006471724

### 1. CHECK PRE-CRASH SEAT BELT CONTROL UNIT INPUT SIGNAL

Check that voltage between seat belt buckle switch (passenger side) and ground.

(+)		(-)	Condition	Voltage (V) (Approx.)
Connector	Terminal			
B213	1	Ground	When driver side seat belt is not fastened	5 or more
			When driver side seat belt is fastened	0

Is the inspection result normal?

YES >> Seat belt buckle switch (passenger side) circuit is normal.

NO >> GO TO 2.

### 2. CHECK SEAT BELT BUCKLE (PASSENGER SIDE) SWITCH CIRCUIT

- Turn ignition switch OFF.
- Disconnect pre-crash seat belt control unit connector and seat belt buckle switch (passenger side) connector.
- Check continuity between pre-crash seat belt control unit and seat belt buckle switch (passenger side).

Pre-crash seat belt control unit		Seat belt buckle switch (passenger side)		Continuity
Connector	Terminal	Connector	Terminal	
M110	8	B213	1	Existed

- Check continuity between pre-crash seat belt control unit and ground.

Pre-crash seat belt control unit		Ground	Continuity
Connector	Terminal		
M110	8		Not existed

Is the inspection result normal?

YES >> GO TO 3.

NO >> Repair or replace harness between pre-crash seat belt control unit and seat belt buckle switch (passenger side).

### 3. CHECK SEAT BELT BUCKLE SWITCH GROUND CIRCUIT

Check continuity between seat belt buckle switch (passenger side) and ground.

Seat belt buckle switch (passenger side)		Ground	Continuity
Connector	Terminal		
B213	2		Existed

Is the inspection result normal?

YES >> GO TO 4.

NO >> Repair or replace harness between seat belt buckle switch and ground.

### 4. CHECK SEAT BELT BUCKLE SWITCH (PASSENGER SIDE)

Check seat belt buckle switch (passenger side). Refer to [SBC-26. "PASSENGER SIDE : Component Inspection"](#).

Is the inspection result normal?

YES >> Replace pre-crash seat belt control unit. Refer to [SBC-61. "Removal and Installation"](#).

NO >> Replace seat belt buckle switch (passenger side).

# SEAT BELT BUCKLE SWITCH

< DTC/CIRCUIT DIAGNOSIS >

## PASSENGER SIDE : Component Inspection

INFOID:000000006471725

### 1. CHECK SEAT BELT BUCKLE SWITCH (PASSENGER SIDE)

1. Turn ignition switch OFF.
2. Disconnect seat belt buckle switch connector.
3. Check continuity of seat belt buckle (passenger side).

Seat belt buckle switch (passenger side)		Condition	Continuity
Terminal			
1	2	When driver side seat belt is not fastened	Not existed
		When driver side seat belt is fastened	Existed

Is the inspection result normal?

- YES >> INSPECTION END  
NO >> Replace seat belt buckle switch (passenger side).

# POWER SUPPLY AND GROUND CIRCUIT

< DTC/CIRCUIT DIAGNOSIS >

## POWER SUPPLY AND GROUND CIRCUIT

### Diagnosis Procedure

INFOID:000000006471726

#### 1.CHECK FUSE

Check that the following fuse and fusible link are not blown.

Terminal No.	Signal name	Fuse No.
13	Battery power supply	1

Is the fuse blown?

- YES >> Replace the blown fuse after repairing the affected circuit if a fuse or fusible link is blown.  
NO >> GO TO 2.

#### 2.CHECK POWER SUPPLY CIRCUIT

1. Turn ignition switch OFF.
2. Disconnect pre-crash seat belt control unit connectors.
3. Check voltage between harness pre-crash seat belt control unit connector and ground.

Pre-crash seat belt control unit		Ground	Voltage (V) (Approx.)
Connector	Terminal		Battery voltage
M110	13		

Is the measurement value normal?

- YES >> GO TO 3.  
NO >> Repair or replace harness.

#### 3.CHECK GROUND CIRCUIT

Check continuity between pre-crash seat belt control unit harness connector and ground.

Pre-crash seat belt control unit		Ground	Continuity
Connector	Terminal		Existed
M110	5		
	26		

Does continuity exist?

- YES >> INSPECTION END  
NO >> Repair or replace harness.

A  
B  
C  
D  
E  
F  
G  
I  
J  
K  
L  
M  
N  
O  
P

SBC

# SEAT BELT WARNING LAMP CIRCUIT

< DTC/CIRCUIT DIAGNOSIS >

## SEAT BELT WARNING LAMP CIRCUIT

### Diagnosis Procedure

INFOID:000000006471727

#### 1. CHECK SEAT BELT WARNING LAMP CIRCUIT

1. Turn ignition switch OFF.
2. Disconnect combination meter connector.
3. Turn ignition switch ON.
4. Check that voltage between combination meter harness connector and ground.

Combination meter		Ground	Voltage (V) (Approx.)
Connector	Terminal		Battery voltage
M53	36		

Is the inspection result normal?

YES >> GO TO 2.

NO >> Repair or replace combination meter. Refer to [MWI-131, "Removal and Installation"](#).

#### 2. CHECK SEAT BELT WARNING LAMP CIRCUIT

1. Turn ignition switch OFF.
2. Disconnect air bag diagnosis sensor unit connector.
3. Check continuity between combination meter harness connector and air bag diagnosis sensor unit harness connector.

Combination meter		Air bag diagnosis sensor unit		Continuity
Connector	Terminal	Connector	Terminal	
B53	36	M147	24	Existed

4. Check continuity between combination meter and ground.

Combination meter		Ground	Continuity
Connector	Terminal		Not existed
B53	36		

Is the inspection result normal?

YES >> Replace air bag diagnosis sensor unit. Refer to [SR-30, "Removal and Installation"](#).

NO >> Repair or replace harness.

# SEAT BELT WARNING SYSTEM

< DTC/CIRCUIT DIAGNOSIS >

## SEAT BELT WARNING SYSTEM

Wiring Diagram - SEAT BELT WARNING SYSTEM -

INFOID:000000006471728

### SEAT BELT WARNING SYSTEM

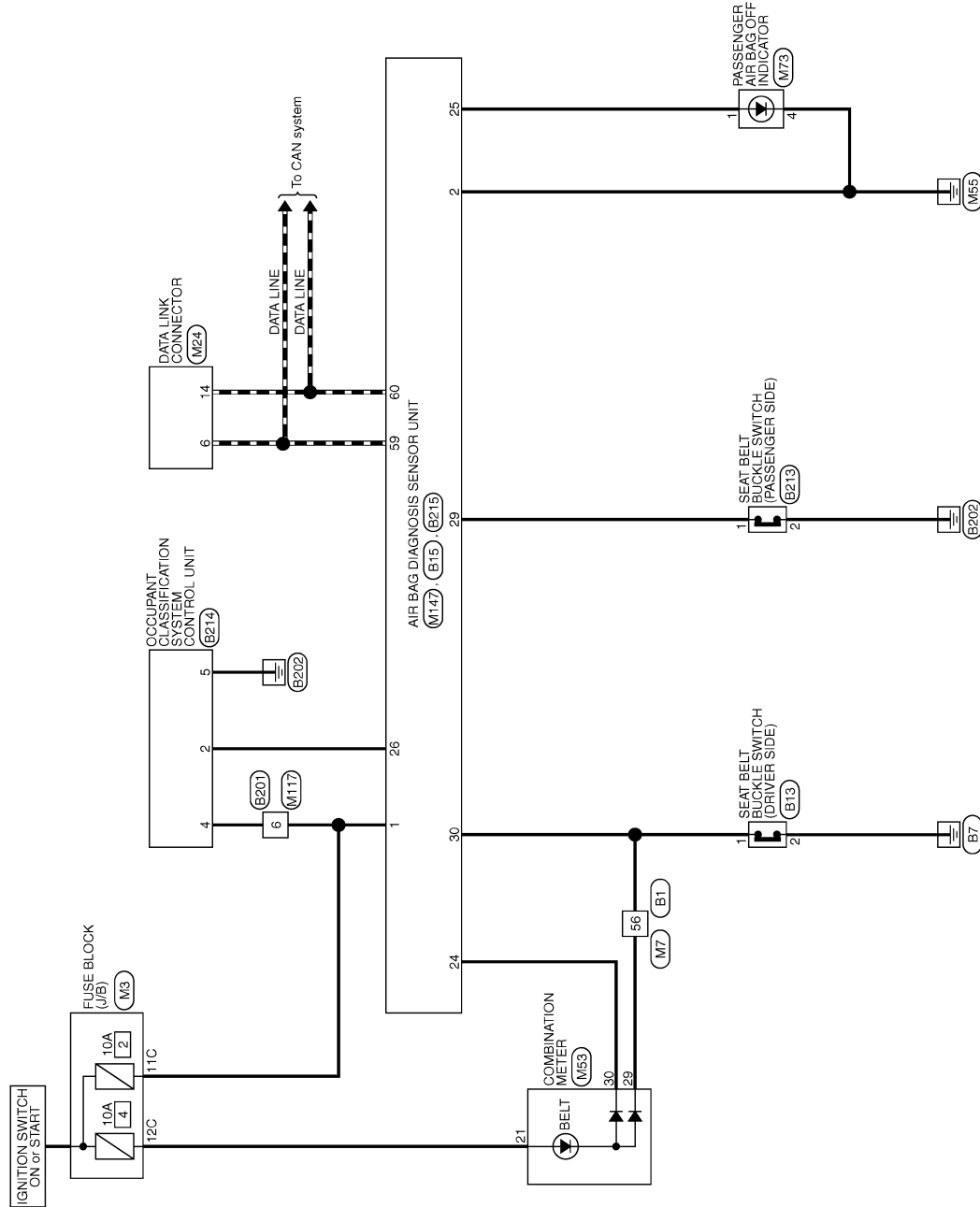

2009/02/27

JCHWA0341GB

A  
B  
C  
D  
E  
F  
G  
H  
I  
J  
K  
L  
M  
N  
O  
P

SBC

# SEAT BELT WARNING SYSTEM

< DTC/CIRCUIT DIAGNOSIS >

## SEAT BELT WARNING SYSTEM

Connector No.	B1
Connector Name	WIRE TO WIRE
Connector Type	THB07V-CS16-TM44

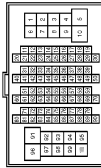

Terminal No.	Color of Wire	Signal Name [Specification]
1	W	
2	L	
3	R	
4	V	
5	W	
6	B	
8	G	
10	BR	
12	SHIELD	
13	Y	
14	L	
15	R	
16	W	
17	BR	
20	G	
21	SB	
22	GR	
23	W	
24	SB	
25	BR	
26	LG	
27	Y	
28	R	
29	V	
31	SHIELD	
32	G	
33	R	
34	BG	
35	GR	
36	BR	
37	P	- [With climate controlled seat]
37	Y	- [Without climate controlled seat]
38	V	- [With climate controlled seat]
38	GR	- [Without climate controlled seat]
40	SHIELD	
41	L	
42	P	
43	SHIELD	

44	SB	
45	V	
46	W	
47	SB	
48	LG	
49	LG	- [With BOSE system]
49	Y	- [Without BOSE system]
50	SB	
50	LG	- [With BOSE system]
50	LG	- [Without BOSE system]
51	SB	
52	G	
53	LG	
54	BR	
55	Y	
56	W	
57	V	
58	R	
60	R	
61	BG	
62	B	
63	L	
64	P	
65	B	
66	SB	
67	P	
68	L	
69	P	
70	L	
80	G	
81	V	
82	R	
83	BR	
84	G	
85	L	
86	Y	
87	GR	
91	R	
93	BG	
94	P	
95	GR	
96	GR	
97	SB	
99	Y	
100	Y/B	

Connector No.	B13
Connector Name	SEAT BELT BUCKLE SWITCH (DRIVER SIDE)
Connector Type	A03FW

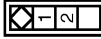

Terminal No.	Color of Wire	Signal Name [Specification]
1	W	
2	B	

Connector No.	B15
Connector Name	AIR BAG DIAGNOSIS SENSOR UNIT
Connector Type	IMP2FY-2V-EX

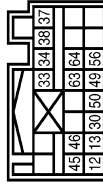

Terminal No.	Color of Wire	Signal Name [Specification]
12	Y	PLH (+)
13	Y	PLH (-)
30	SB	LH BUCKLE SW INPUT
33	Y	SUH (+)
34	Y	SUH (-)
37	Y/B	GLH (+)
38	Y	GLH (-)
49	P	SATELLITE LH (+)
50	L	SATELLITE LH (-)
56	SHIELD	GND
63	Y	ELH (+)
64	Y/B	ELH (-)

JCHWM0872GB

# SEAT BELT WARNING SYSTEM

< DTC/CIRCUIT DIAGNOSIS >

## SEAT BELT WARNING SYSTEM

Connector No.	B201
Connector Name	WIRE TO WIRE
Connector Type	TH80FW-CS16-TM4



Terminal No.	Color of Wire	Signal Name [Specification]
1	W	
2	W	
3	B	
4	W	
5	W	
6	R	
7	B	
7	G	
8	BG	
9	GR	
10	LG	
40	GR	
41	LG	
42	BG	
43	R	
44	SHIELD	
45	G	
47	G	
48	Y	
48	SHIELD	
50	P	
51	SB	
52	LG	
53	L	
54	G	
55	GR	
56	LG	
57	G	
58	R	
67	L	
68	P	
80	G	
81	R	
82	W	
83	B	
84	SHIELD	
85	O	
86	BR	
87	Y	
88	SHIELD	

89	SB	-
90	V	-
91	GR	-
92	P	- [With BOSE system]
92	Y	- [Without BOSE system]
93	L	-
94	SB	-
95	V	-
96	P	-
97	L	- [With BOSE system]
97	LG	- [Without BOSE system]
98	Y/B	-
99	Y	-

Connector No.	B213
Connector Name	SEAT BELT BUCKLE SWITCH (PASSENGER SIDE)
Connector Type	A03FW

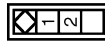

Terminal No.	Color of Wire	Signal Name [Specification]
1	LG	
2	B	

Connector No.	B214
Connector Name	OCCUPANT CLASSIFICATION SYSTEM CONTROL UNIT
Connector Type	TH80FW-HH

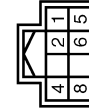

Terminal No.	Color of Wire	Signal Name [Specification]
2	V	COMMUNICATION
4	R	IGN
5	B	GND

Connector No.	B215
Connector Name	AIR BAG DIAGNOSIS SENSOR UNIT
Connector Type	TH22FY-IV-EX

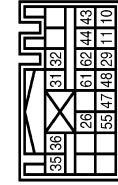

Terminal No.	Color of Wire	Signal Name [Specification]
10	Y	PRH (+)
11	Y	PRH (-)
26	V	ODS INPUT
28	LG	RH BUCKLE SW INPUT
31	Y	SRH (+)
32	Y	SRH (-)
33	Y/B	CRH (+)
33	Y	CRH (-)
47	G	SATELLITE RH (+)
48	R	SATELLITE RH (-)
55	SHIELD	GND
61	Y	ERH (+)
62	Y/B	ERH (-)

Connector No.	M3
Connector Name	FUSE BLOCK (J/B)
Connector Type	NS12FW-CS



Terminal No.	Color of Wire	Signal Name [Specification]
8C	R	-
7C	B	-
8C	W	-
9C	BG	-
10C	L	-
11C	LG	-
12C	R	-

A  
B  
C  
D  
E  
F  
G  
SBC  
I  
J  
K  
L  
M  
N  
O  
P

# SEAT BELT WARNING SYSTEM

## < DTC/CIRCUIT DIAGNOSIS >

### SEAT BELT WARNING SYSTEM

Connector No.	M7
Connector Name	WIRE TO WIRE
Connector Type	TH80MW-CS16-TIM

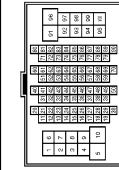

Terminal No.	Color of Wire	Signal Name [Specification]
1	BG	-
2	LG	-
3	G	-
4	V	-
5	L	-
6	B	-
8	L	-
10	BR	-
12	SHIELD	-
13	V	-
14	BR	-
15	GR	-
16	LG	-
17	L	-
20	BR	-
21	G	-
22	R	-
23	SB	-
24	B	-
25	W	-
26	Y	-
27	V	-
28	P	-
29	V	-
31	SHIELD	-
32	G	-
33	R	-
34	BG	-
35	GR	-
36	BR	-
37	P	- [With climate controlled seat]
37	L	- [Without climate controlled seat]
38	V	- [With climate controlled seat]
38	GR	- [Without climate controlled seat]
40	SHIELD	-
41	L	-
42	P	-
43	SHIELD	-

Connector No.	M24
Connector Name	DATA LINK CONNECTOR
Connector Type	BD16FW

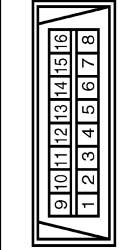

Terminal No.	Color of Wire	Signal Name [Specification]
3	LG	-
4	B	-
5	BR	-
6	L	-
7	V	-
8	G	-
11	SB	-
14	P	-
16	R	-

Connector No.	M53
Connector Name	COMBINATION METER
Connector Type	SAB40FW

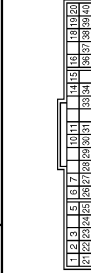

Terminal No.	Color of Wire	Signal Name [Specification]
1	V	BATTERY POWER SUPPLY
2	LG	COMMUNICATION SIGNAL (METER->METER)
3	GR	GROUND
5	B	GROUND
6	W	ALTERNATOR SIGNAL
7	LG	AIR BAG SIGNAL
10	R	SECURITY SIGNAL
15	B	GROUND
16	B	METER CONTROL SWITCH GROUND
18	GR	ILL GND
19	B	ILL
20	R	ILL
21	R	IGNITION SIGNAL

22	B	GROUND
24	SB	COMMUNICATION SIGNAL (LGD->AMP)
25	B	COMMUNICATION SIGNAL (AMP->LGD)
26	R	VEHICLE SPEED SIGNAL (G-FULSE)
27	V	PARKING BRAKE SWITCH SIGNAL
28	SB	BRAKE FLUID LEVEL SWITCH SIGNAL
29	L	SEAT BELT BUCKLE SW SIGNAL (DRIVER SIDE)
30	G	SEAT BELT BUCKLE SWITCH SIGNAL (PASSENGER SIDE)
31	L	WASHER LEVEL SWITCH SIGNAL
33	R	ILLUMINATION CONTROL SIGNAL
36	LG	SELECT SWITCH SIGNAL
37	SB	ENTER SWITCH SIGNAL
38	L	TRIP A/B RESET SWITCH SIGNAL
39	P	ILLUMINATION CONTROL SWITCH (-)
40	BG	ILLUMINATION CONTROL SWITCH (+)

Connector No.	M73
Connector Name	PASSENGER AIR BAG OFF INDICATOR
Connector Type	TH80MW-NH



Terminal No.	Color of Wire	Signal Name [Specification]
1	R	-
4	B	-



# SEAT BELT WARNING SYSTEM

< DTC/CIRCUIT DIAGNOSIS >

A  
B  
C  
D  
E  
F  
G  
SBC  
I  
J  
K  
L  
M  
N  
O  
P

## SEAT BELT WARNING SYSTEM

Connector No.	M117
Connector Name	WIRE TO WIRE
Connector Type	THROMW-CS (F-TM4)



90	W	-
91	GR	-
92	P	-
93	W	-
94	BG	-
95	BG	-
96	P	-
97	L	-
98	Y/B	-
99	Y	-

Terminal No.	Color of Wire	Signal Name [Specification]
1	Y	-
3	B	-
5	SB	-
6	R	-
7	G	-
8	SB	-
9	GR	-
10	LG	-
40	Y	-
41	G	-
42	LG	-
43	R	-
44	SHIELD	-
45	G	-
47	P	-
48	L	-
49	SHIELD	-
50	V	-
51	SB	-
52	BG	-
53	L	-
54	G	-
55	Y	-
56	LG	-
57	SB	-
58	LG	-
68	LG	-
80	W	-
81	B	-
82	R	-
83	G	-
84	SHIELD	-
85	G	-
86	L	-
87	P	-
88	SHIELD	-
88	Y	-

Connector No.	M147
Connector Name	AIR BAG DIAGNOSIS SENSOR UNIT
Connector Type	M128FY-EX

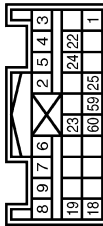

Terminal No.	Color of Wire	Signal Name [Specification]
1	LG	IGN
2	B	GND
3	Y	DRL (-)
4	Y	DRI (-) DR2 (-)
5	Y	DR2 (-)
6	Y	ASI (-)
7	Y	ASI (-)
8	Y	ASS (-)
9	Y	ASS (-)
18	SB	EC2S (-)
19	SB	EC2S (-)
22	SHIELD	GND
23	LG	AIRBAG W/L
24	G	SEAT BELT
25	R	CUTOFF TELLTALE
59	L	CAN-H
60	P	CAN-L

JCHWM0875GB

# PRE-CRASH SEAT BELT CONTROL UNIT

< ECU DIAGNOSIS INFORMATION >

## ECU DIAGNOSIS INFORMATION

### PRE-CRASH SEAT BELT CONTROL UNIT

Reference Value

INFOID:000000006471729

VALUES ON THE DIAGNOSIS TOOL  
CONSULT-III MONITOR ITEM

Monitor item	Condition	Value/Status (Approx.)
B PEDAL SIG1	Brake released → depressed	1 V→4 V
B PEDAL SIG2	Brake released → depressed	4 V→1 V
SB SW RH SIG	RH seat belt is not fastened	OFF
	RH seat belt is fastened	ON
SB SW LH SIG	LH seat belt is not fastened	OFF
	LH seat belt is fastened	ON

### TERMINAL LAYOUT

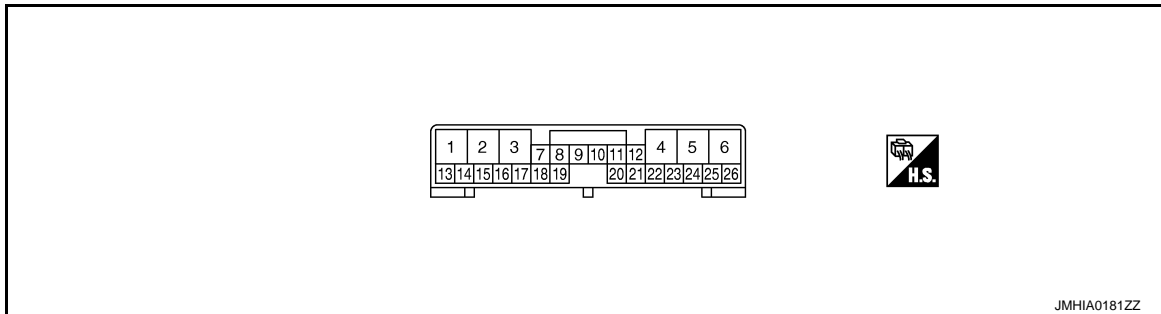

### PHYSICAL VALUES

Terminal No. (Wire color)		Description		Condition	Value (*1) (Approx.)
+	-	Signal name	Input/Output		
1 (G/R)	Ground	RH seat belt motor release signal	Output	—	—
2 (W)	Ground	Drive circuit power supply (+BAT)	Input	Seat belt motor non-operational	Battery voltage
3 (G/Y)	Ground	RH seat belt motor forward (retract) signal	Output	—	—
4 (GR/W)	Ground	LH seat belt motor forward (retract) signal	Output	—	—
5 (W)	Ground	Drive circuit ground	—	—	0
6 (LY)	Ground	LH seat belt motor release signal	Output	—	—
7 (G)	Ground	Indicator (seat belt warning lamp)	Output	LH seat belt is not fastened	Ground
				LH seat belt is fastened	Battery voltage
				LH seat belt is fastened or malfunction of system	Battery voltage ↔ Ground
8 (LG)	Ground	RH seat belt buckle switch signal	Input	RH seat belt is fastened	5 V or more
				RH seat belt is not fastened	Ground

# PRE-CRASH SEAT BELT CONTROL UNIT

## < ECU DIAGNOSIS INFORMATION >

Terminal No. (Wire color)		Description		Condition	Value (*1) (Approx.)
+	-	Signal name	Input/ Output		
10 (SB)	Ground	LH seat belt buckle switch signal	Input	LH seat belt is fastened	Battery voltage
				LH seat belt is not fastened	Ground
13 (W)	Ground	Control circuit power supply (IGN)	Input	IGN ON	Battery voltage
				IGN OFF	Ground
16 (W)	Ground	Brake pedal stroke sensor signal1	Input	Brake released → depressed	1 V → 4 V
				IGN OFF	0 V
18 (R)	Ground	Brake pedal stroke sensor power circuit	Output	IGN ON	5 V
				IGN OFF	0 V
20 (G)	Ground	Brake pedal stroke sensor signal2	Input	Brake released → depressed	4 V → 1 V
				IGN OFF	0V
21 (B)	Ground	Brake pedal stroke sensor ground circuit	—	—	Ground
22 (P)	Ground	CAN communication signal (CAN L-line)	Input/ Output	—	—
24 (L)	Ground	CAN communication signal (CAN H-line)	Input/ Output	—	—
25	Ground	Shield ground	—	—	Ground
26 (B)	Ground	Control circuit ground	—	—	Ground

\*1: Perform the measurement while connecting the control unit and the harness.

## Fail Safe

INFOID:000000006471730

When a malfunction occurs in the following system, the pre-crash seat belt function is controlled according to the malfunctioning parts.

Display contents of CONSULT-III	Fail-safe	Cancellation
B2451: SB MOTOR RH CIRC	Deactivate the RH pre-crash seat belt function	Erase DTC
B2452: SB MOTOR LH CIRC	Deactivate the LH pre-crash seat belt function	Erase DTC
B2453: BR STROK SEN CIRC	Deactivate the interlock function during emergency brake operation	Erase DTC
B2454: MOTOR PWR SUP CIRC	Deactivate the pre-crash seat belt function	Erase DTC

## DTC Index

INFOID:000000006471731

DTC	Trouble diagnosis name (CONSULT-III display)	DTC detection condition	Reference
—	—	No malfunction is detected	—
U1000	CAN COMM CIRCUIT	Pre-crash seat belt control unit cannot transmit and receive CAN communication signal for 2 seconds or more	<a href="#">SBC-15</a>
B2451	SB MOTOR RH CIRC	RH seat belt motor circuit is shorted or open	<a href="#">SBC-16</a>
B2452	SB MOTOR LH CIRC	LH seat belt motor circuit is shorted or open	<a href="#">SBC-17</a>
B2453	BR STROK SEN CIRC	Brake pedal stroke sensor circuit is shorted or open	<a href="#">SBC-18</a>
B2454	MOTOR PWR SUP CIRC	Motor power supply circuit is shorted or open	<a href="#">SBC-21</a>
B2455	PSB C/U INT CIRCUIT	Internal breakdown in pre-crash seat belt control unit	<a href="#">SBC-22</a>

# PRE-CRASH SEAT BELT CONTROL UNIT

< ECU DIAGNOSIS INFORMATION >

## Wiring Diagram - PRE-CRASH SEAT BELT SYSTEM -

INFOID:000000006471732

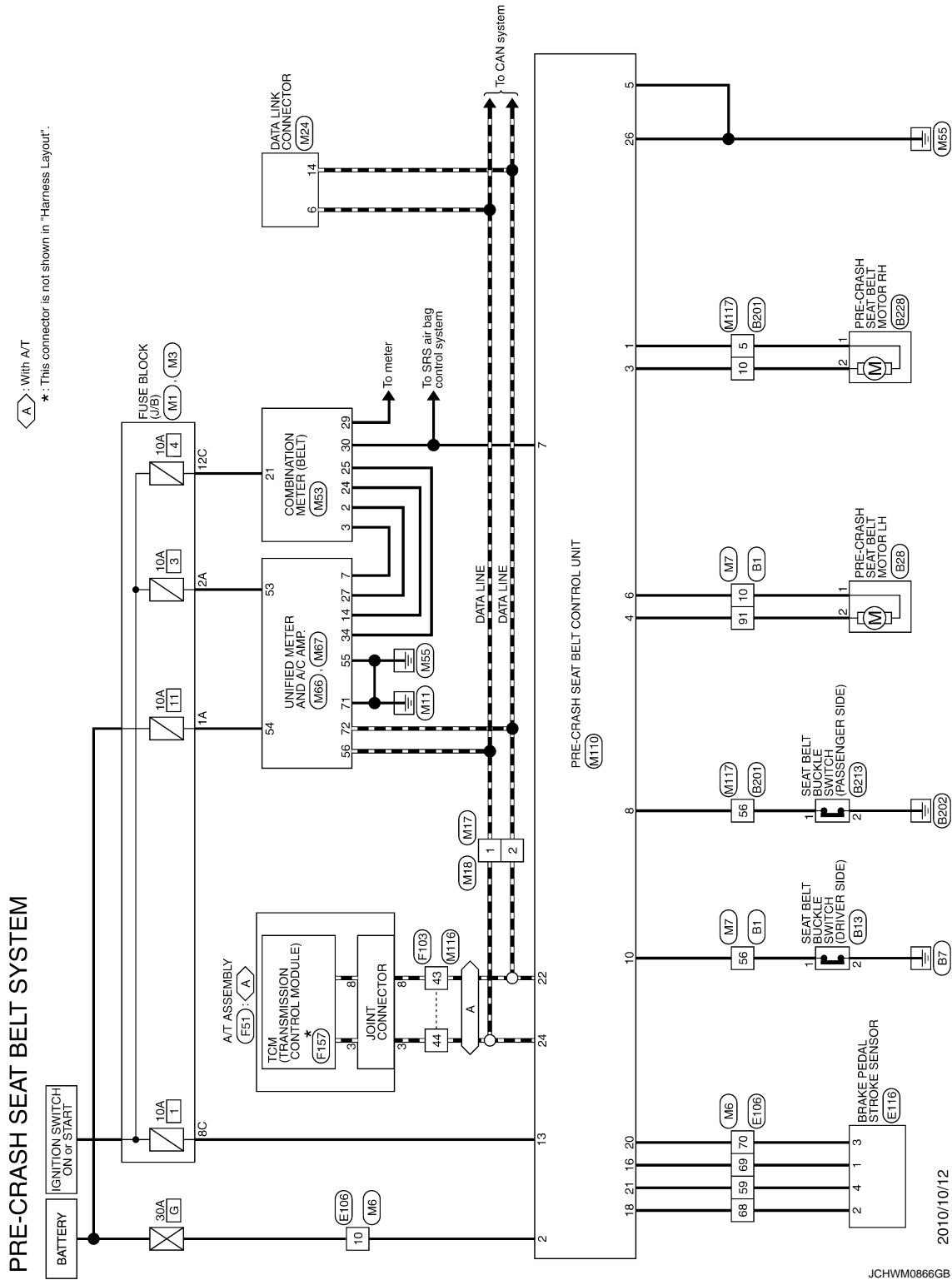

# PRE-CRASH SEAT BELT CONTROL UNIT

## < ECU DIAGNOSIS INFORMATION >

### PRE-CRASH SEAT BELT SYSTEM

Connector No.	B1
Connector Name	WIRE TO WIRE
Connector Type	TH80FW-CS16-TM4

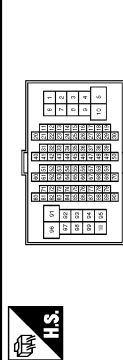

Terminal No.	Color of Wire	Signal Name [Specification]
1	W	
2	L	
3	R	
4	V	
5	W	
6	B	
7	G	
8	G	
9	G	
10	BR	
11	SHIELD	
12	Y	
13	Y	
14	L	
15	R	
16	W	
17	BR	
18	G	
19	G	
20	G	
21	SB	
22	GR	
23	W	
24	SB	
25	BR	
26	LG	
27	Y	
28	R	
29	V	
30	SHIELD	
31	SHIELD	
32	G	
33	R	
34	BG	
35	GR	
36	BR	
37	P	
38	Y	
39	V	
40	GR	
41	SHIELD	
42	L	
43	P	
44	SHIELD	

44	SB	
45	V	
46	W	
47	SB	
48	LG	
49	LG	
49	Y	
50	SB	
50	LG	
51	SB	
52	G	
53	LG	
54	BR	
55	Y	
56	W	
57	V	
58	R	
60	R	
61	EG	
62	B	
63	L	
64	P	
65	B	
66	SB	
67	P	
68	L	
69	P	
70	L	
80	G	
81	V	
82	R	
83	BR	
84	G	
85	L	
86	Y	
87	GR	
88	R	
89	EG	
90	P	
95	GR	
96	GR	
97	SB	
99	Y	
100	Y/B	

Connector No.	B13
Connector Name	SEAT BELT BUCKLE SWITCH (DRIVER SIDE)
Connector Type	A33FW

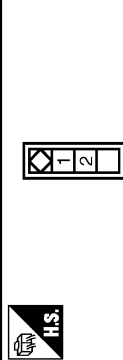

Terminal No.	Color of Wire	Signal Name [Specification]
1	W	
2	B	

Connector No.	B22
Connector Name	PRE-CRASH SEAT BELT MOTOR LH
Connector Type	TB02FW-ZV

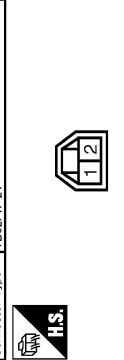

Terminal No.	Color of Wire	Signal Name [Specification]
1	BR	
2	R	

Connector No.	B201
Connector Name	WIRE TO WIRE
Connector Type	TH80FW-CS16-TM4

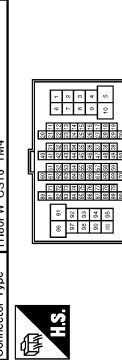

Terminal No.	Color of Wire	Signal Name [Specification]
1	W	
3	B	

5	W	
6	R	
7	B	
7	G	
8	BG	
9	GR	
10	LG	
40	GR	
41	LG	
42	BG	
43	R	
44	SHIELD	
45	G	
47	G	
48	Y	
49	SHIELD	
50	P	
51	SB	
52	LG	
53	L	
54	G	
55	GR	
56	LG	
57	G	
58	R	
67	L	
68	P	
80	G	
81	R	
82	W	
83	B	
84	SHIELD	
85	O	
86	BR	
87	Y	
88	SHIELD	
89	SB	
90	V	
91	GR	
92	P	
93	L	
94	SB	
95	V	
96	P	
97	L	
97	LG	
98	Y/B	
99	Y	

A  
B  
C  
D  
E  
F  
G  
H  
I  
J  
K  
L  
M  
N  
O  
P

SBC

JCHWM0867GB

# PRE-CRASH SEAT BELT CONTROL UNIT

< ECU DIAGNOSIS INFORMATION >

## PRE-CRASH SEAT BELT SYSTEM

Connector No.	B213
Connector Name	SEAT BELT BUCKLE SWITCH (PASSENGER SIDE)
Connector Type	AC3FW

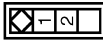

Terminal No.	Color of Wire	Signal Name [Specification]
1	LG	
2	B	

Connector No.	B228
Connector Name	PRE-CRASH SEAT BELT MOTOR RH
Connector Type	TB02FW-2V



Terminal No.	Color of Wire	Signal Name [Specification]
1	W	
2	LG	

Connector No.	E106
Connector Name	WIRE TO WIRE
Connector Type	THB0FW-CS16-TM4

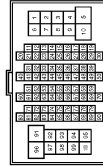

Terminal No.	Color of Wire	Signal Name [Specification]
1	GR	
3	BG	

Terminal No.	Color of Wire	Signal Name [Specification]
4	B/W	
5	G	
6	BG	
7	LG	
8	G	
9	R	
10	W	
11	V	
12	R	
13	L	
14	GR	
15	P	
16	W	
17	V	
18	BG	
19	GR	
20	LG	
30	R	
31	L	
32	BG	
33	P	
34	V	
35	BR	
36	W	
37	Y	
38	R	
39	B	
40	G	
41	W	
42	LG	
43	SB	
44	GR	
45	BG	
46	LG	
47	V	
48	P	
49	L	
59	B	
66	LG	
67	SB	
68	R	
69	W	
70	G	
80	W	
81	P	
82	G	
83	V	
84	L	
85	BG	
86	LG	
87	Y	
88	GR	

Terminal No.	Color of Wire	Signal Name [Specification]
89	W	
90	W	
91	G	
92	B	
93	GR	
94	L	
95	Y	
97	BR	
98	SHIELD	
99	L	
100	P	

Connector No.	E116
Connector Name	BRAKE PEDAL STROKE SENSOR
Connector Type	HSMFB



Terminal No.	Color of Wire	Signal Name [Specification]
1	W	S1
2	R	VCC
3	G	S2
4	B	GND

Connector No.	F51
Connector Name	A-T ASSEMBLY
Connector Type	RK10FG-DCY

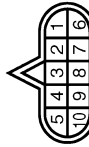

Terminal No.	Color of Wire	Signal Name [Specification]
1	Y	
2	R	
3	L	
4	V	
5	B	

Terminal No.	Color of Wire	Signal Name [Specification]
6	Y	
7	R	
8	P	
9	GR	
10	B	

Connector No.	F103
Connector Name	WIRE TO WIRE
Connector Type	TK38FW-NS10



Terminal No.	Color of Wire	Signal Name [Specification]
2	G	
3	W	
4	R	
5	B	
9	Y	
10	GR	
19	O	
20	Y	
28	B	
29	LG	
30	R	
31	R	
41	O	
42	BR	
43	P	
44	L	
45	Y	
46	V	

JCHWM00868GB

# PRE-CRASH SEAT BELT CONTROL UNIT

< ECU DIAGNOSIS INFORMATION >

A  
B  
C  
D  
E  
F  
G  
H  
I  
J  
K  
L  
M  
N  
O  
P

SBC

## PRE-CRASH SEAT BELT SYSTEM

Connector No.	F157
Connector Name	TCM (TRANSMISSION CONTROL MODULE)
Connector Type	SP10FG

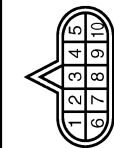

Terminal No.	Color of Wire	Signal Name [Specification]
1	-	VIGN
2	-	BATT
3	-	CAN-H
4	-	K-LINE
5	-	GND
6	-	VIGN
7	-	REV LAMP RLY
8	-	CAN-L
9	-	STARTER RLY
10	-	GND

Connector No.	M1
Connector Name	FUSE BLOCK (J/B)
Connector Type	NS08FW-M2

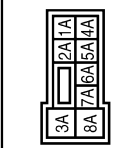

Terminal No.	Color of Wire	Signal Name [Specification]
1A	V	-
2A	G	-
3A	L	-
4A	P	-
5A	BR	-
6A	Y	-
7A	GR	-
8A	L	-

Connector No.	M3
Connector Name	FUSE BLOCK (J/B)
Connector Type	NS12FF-CS

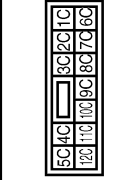

Terminal No.	Color of Wire	Signal Name [Specification]
6C	R	-
7C	B	-
8C	W	-
9C	EG	-
10C	L	-
11C	LG	-
12C	R	-

Connector No.	M6
Connector Name	WIRE TO WIRE
Connector Type	TH80MW-CS16-TM4

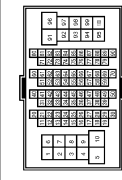

Terminal No.	Color of Wire	Signal Name [Specification]
1	EG	-
3	R	-
4	G	-
5	G	-
6	BR	-
7	BR	-
8	Y	-
9	R	-
10	W	-
11	GR	-
12	R	-
13	L	-
14	G	-
15	P	-
16	W	-

17	BR	-
18	V	-
19	EG	-
20	L	-
30	R	-
31	L	-
32	Y	-
33	GR	-
34	P	-
35	BR	-
36	BR	-
37	Y	-
38	LG	-
39	SB	-
40	G	-
41	W	-
42	LG	-
43	P	-
44	GR	- [With A/T]
44	R	- [With M/T]
45	EG	-
46	G	-
47	P	-
48	P	-
49	L	-
59	B	-
66	Y	-
67	G	-
68	R	-
69	W	-
70	G	-
80	SB	-
81	R	-
82	V	-
83	W	-
84	L	-
85	EG	-
86	G	-
87	V	-
88	B	-
89	SB	-
90	G	-
91	W	-
92	B	-
93	G	-
94	L	-
95	BR	-
97	P	-
98	SHIELD	-
99	V	-
100	SB	-

# PRE-CRASH SEAT BELT CONTROL UNIT

## < ECU DIAGNOSIS INFORMATION >

### PRE-CRASH SEAT BELT SYSTEM

Connector No.	M7
Connector Name	WIRE TO WIRE
Connector Type	TH80MW-CS16-TIM4

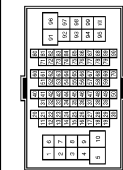

44	Y		
45	BR		
46	SB		
47	SB		
48	LG		
49	LG		
49	SB		
50	SB		
50	LG		
51	R		
52	V		
53	P		
54	BR		
55	Y		
55	BG		
56	L		
57	V		
58	R		
60	LG		
61	BG		
62	B		
63	V		
64	SB		
65	BR		
66	Y		
67	P		
68	L		
69	P		
70	L		
80	G		
81	LG		
82	Y		
83	BR		
84	V		
85	L		
86	Y		
87	GR		
81	R		
83	G		
94	P		
95	GR		
96	Y		
97	SB		
99	Y		
100	Y/B		

5	BR		
6	L		
7	V		
8	G		
11	SB		
14	P		
16	R		

Connector No.	M53
Connector Name	COMBINATION METER
Connector Type	SAB40FW

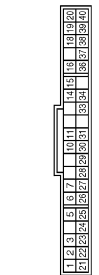

Terminal No.	Color of Wire	Signal Name [Specification]
1	V	BATTERY POWER SUPPLY
2	LG	COMMUNICATION SIGNAL (METER->AMP.)
3	GR	COMMUNICATION SIGNAL (AMP->METER)
5	B	GROUND
6	W	ALTERNATOR SIGNAL
7	LG	AIR BAG SIGNAL
10	R	SECURITY SIGNAL
15	B	GROUND
16	B	METER CONTROL SWITCH GROUND
18	GR	ILL GND
19	B	ILL GND
20	R	ILL
21	R	IGNITION SIGNAL
22	B	GROUND
24	SB	COMMUNICATION SIGNAL (LGD->AMP.)
25	B	COMMUNICATION SIGNAL (AMP->LGD)
26	R	VEHICLE SPEED SIGNAL (8-PULSE)
27	V	PARKING BRAKE SWITCH SIGNAL
28	SB	BRAKE FLUID LEVEL SWITCH SIGNAL
29	L	SEAT BELT BUCKLE SW SIGNAL (DRIVER SIDE)
30	G	SEAT BELT BUCKLE SW SIGNAL (PASSENGER SIDE)
31	L	WASHER LEVEL SWITCH SIGNAL
33	R	ILLUMINATION CONTROL SIGNAL
36	LG	SELECT SWITCH SIGNAL
37	SB	ENTER SWITCH SIGNAL
38	L	TRIP A/B RESET SWITCH SIGNAL
39	P	ILLUMINATION CONTROL SWITCH (-)
40	BG	ILLUMINATION CONTROL SWITCH (+)

Connector No.	M17
Connector Name	WIRE TO WIRE
Connector Type	TKG2FW



Terminal No.	Color of Wire	Signal Name [Specification]
1	L	
2	P	

Connector No.	M18
Connector Name	WIRE TO WIRE
Connector Type	TKG2MW



Terminal No.	Color of Wire	Signal Name [Specification]
1	L	
2	P	

Connector No.	M24
Connector Name	DATA LINK CONNECTOR
Connector Type	BD16FW

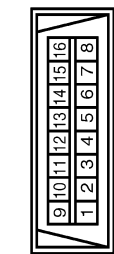

Terminal No.	Color of Wire	Signal Name [Specification]
3	LG	
4	B	

JCHWM0870GB



# PRE-CRASH SEAT BELT CONTROL UNIT

< ECU DIAGNOSIS INFORMATION >

## PRE-CRASH SEAT BELT SYSTEM

Connector No.	M86
Connector Name	UNIFIED METER AND A/C AMP.
Connector Type	TH42PV-NH

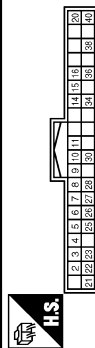

Terminal No.	Color of Wire	Signal Name [Specification]
4	G	STOP LAMP SWITCH
5	L	MANUAL MODE SHIFT UP SIGNAL
6	BG	PADDLE SHIFTER UP SIGNAL
7	GR	COMMUNICATION SIGNAL (AMP->METER)
8	L	VEHICLE SPEED (2-PULSE)
9	SB	SEAT BELT BUCKLE SWITCH SIGNAL (DRIVER SIDE)
10	W	MANUAL MODE SIGNAL
11	G	NON-MANUAL MODE SIGNAL
14	SB	COMMUNICATION SIGNAL (LCP->AMP)
20	G	IGN ON / OFF SIGNAL
25	V	MANUAL MODE SHIFT DOWN SIGNAL
26	G	PADDLE SHIFTER DOWN SIGNAL
27	LG	COMMUNICATION SIGNAL (METER->AMP)
28	R	VEHICLE SPEED (8-PULSE)
30	V	PARKING BRAKE SWITCH SIGNAL
34	B	COMMUNICATION SIGNAL (AMP->LCD)
38	P	BLOWER MOTOR CONTROL SIGNAL

Connector No.	M87
Connector Name	UNIFIED METER AND A/C AMP.
Connector Type	TH22PV-NH

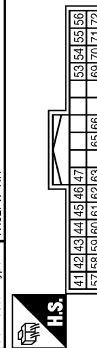

Terminal No.	Color of Wire	Signal Name [Specification]
41	BR	ACC POWER SUPPLY
42	BR	FUEL LEVEL SENSOR SIGNAL
43	R	INTAKE SENSOR SIGNAL
44	LG	IN-VEHICLE SENSOR SIGNAL
45	V	AMBIENT SENSOR SIGNAL

46	BG	SUNLOAD SENSOR SIGNAL
47	G	EXHAUST GAS / OUTSIDE DOOR DETECTING SENSOR SIGNAL
52	W	IGNITION POWER SUPPLY
54	BG	BATTERY POWER SUPPLY
55	B	GROUND
56	L	CAN-H
57	LG	BRAKE FLUID LEVEL SWITCH SIGNAL
58	Y	FUEL LEVEL SENSOR SIGNAL GROUND
59	GR	INTAKE SENSOR GROUND
60	L	IN-VEHICLE SENSOR GROUND
61	R	AMBIENT SENSOR GROUND
62	SB	SUNLOAD SENSOR GROUND
63	L	IGN CONTROL MODE OUTPUT SIGNAL
65	BG	ECV SIGNAL
69	L	A/C LAMP SIGNAL
70	R	EACH DOOR MOTOR POWER SUPPLY
71	GR	GROUND
72	P	CAN-L

Connector No.	M110
Connector Name	PRE-CRASH SEAT BELT CONTROL UNIT
Connector Type	TH20PW-T66

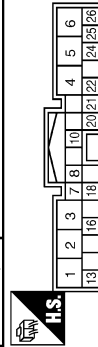

Terminal No.	Color of Wire	Signal Name [Specification]
1	SB	MOTOR (RH) (RELEASE)
2	W	INDICATOR
3	LG	MOTOR (RH) (FASTEN)
4	R	MOTOR (LH) (FASTEN)
5	W	GND (DRIVE)
6	BR	MOTOR (LH) (RELEASE)
7	G	INDICATOR
8	LG	BUCKLE SW RH
10	BR	BUCKLE SW LH
13	W	IGN
16	W	SENS OUTPUT 1
18	R	SENS POWER
20	G	SENS OUTPUT 2
21	B	SENS GND
22	P	CAN-L
24	L	CAN-H
26	B	GND (CONT)

Connector No.	M116
Connector Name	WIRE TO WIRE
Connector Type	TK38MW-NS10

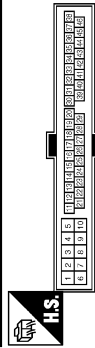

Terminal No.	Color of Wire	Signal Name [Specification]
2	W	—
3	BG	—
4	R	—
5	B	—
9	R	—
10	R	—
19	BG	—
20	Y	—
28	GR	—
29	LG	—
30	LG	—
31	W	—
41	BG	—
42	G	—
43	P	—
44	L	—
45	G	—
46	Y	—

Connector No.	M117
Connector Name	WIRE TO WIRE
Connector Type	TH60MW-CS16-TM4

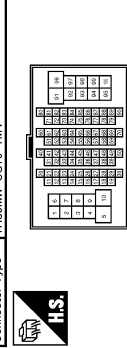

Terminal No.	Color of Wire	Signal Name [Specification]
1	Y	—
3	B	—
5	SB	—
6	R	—

7	G	—
8	SB	—
9	GR	—
10	LG	—
40	Y	—
41	G	—
42	LG	—
43	R	—
44	SHIELD	—
45	G	—
47	P	—
48	L	—
49	SHIELD	—
50	V	—
51	SB	—
52	BG	—
53	L	—
54	G	—
55	Y	—
58	LG	—
57	SB	—
58	LG	—
67	SB	—
68	LG	—
80	W	—
81	B	—
82	R	—
83	G	—
84	SHIELD	—
85	G	—
86	L	—
87	P	—
88	SHIELD	—
89	Y	—
90	W	—
91	GR	—
92	P	—
93	W	—
94	BG	—
95	BG	—
96	P	—
97	L	—
98	Y/B	—
99	Y	—

A  
B  
C  
D  
E  
F  
G  
H  
I  
J  
K  
L  
M  
N  
O  
P

SBC

# DIAGNOSIS SENSOR UNIT

< ECU DIAGNOSIS INFORMATION >

## DIAGNOSIS SENSOR UNIT

### DTC Index

INFOID:00000006471733

DTC	Diagnostic item	Explanation		Reference page
—	NO DTC IS DETECTED.	When malfunction is indicated by the "AIR BAG" warning lamp in the user mode	Low battery voltage (Less than 9 V)	<a href="#">SRC-21, "CONSULT-III Function"</a> .
			Self-diagnostic result is not erased after repair	<a href="#">SRC-15, "Diagnosis with Air Bag Warning Lamp"</a> , <a href="#">SRC-21, "CONSULT-III Function"</a> .
			Intermittent malfunction is detected in the past	<a href="#">GI-43, "Intermittent Incident"</a>
		No malfunction is detected		—
U1000	CAN COMM CIRCUIT	CAN communication system malfunction		<a href="#">SRC-22, "DTC Logic"</a>
U1010	CONTROL UNIT (CAN)	Air bag diagnosis sensor unit is malfunctioning		<a href="#">SRC-23, "DTC Logic"</a>
B1001-B1015	CONTROL UNIT	Air bag diagnosis sensor unit is malfunctioning		<ul style="list-style-type: none"> <li><a href="#">SRC-24, "DTC Logic"</a>.</li> <li><a href="#">SRC-26, "DTC Logic"</a>.</li> <li><a href="#">SRC-28, "DTC Logic"</a>.</li> </ul>
B1017 B1020 B1021	OCCUPANT SENS C/U [UNIT FAIL]	Malfunction occurs in Occupant Classification System control unit		<a href="#">SRC-30, "DTC Logic"</a> .
B1018	OCCUPANT SENS [UNIT FAIL]	Malfunction occurs in Occupant Classification System sensor		<a href="#">SRC-32, "DTC Logic"</a> .
B1022	OCCUPANT SENS C/U [COMM FAIL]	Malfunction occurs in Occupant Classification System control unit, circuit of Occupant Classification System control unit air bag diagnosis sensor unit, or air bag diagnosis sensor unit		<a href="#">SRC-34, "DTC Logic"</a> .
B1023	PASS A/B INDCTR CKT	Passenger air bag OFF indicator circuit is open or shorted to ground or the circuits are shorted each other		<a href="#">SRC-36, "DTC Logic"</a> .
B1025 B1032 B1048	OCS SENSOR	Malfunction occurs in Occupant Classification System control unit, circuit of Occupant Classification System control unit air bag diagnosis sensor unit, or air bag diagnosis sensor unit		<a href="#">SRC-38, "DTC Logic"</a> .
B1026-B1031	CONTROL UNIT	Air bag diagnosis sensor unit is malfunctioning or out of the specified specification		<a href="#">SRC-40, "DTC Logic"</a> .
B1033 B1034	CRASH ZONE SEN [UNIT FAIL]	Crash zone sensor is malfunctioning		<a href="#">SRC-42, "DTC Logic"</a> .
B1035	CRASH ZONE SEN [COMM FAIL]	Crash zone sensor is malfunctioning		<a href="#">SRC-44, "DTC Logic"</a> .
B1036	CRASH ZONE SEN [UNMATCH]	Crash zone sensor is out of the specified specification		<a href="#">SRC-46, "DTC Logic"</a> .
B1037 B1039 B1041	CRASH ZONE SEN1	Crash zone sensor is malfunctioning		<a href="#">SRC-48, "DTC Logic"</a> .
B1042-B1047	CONTROL UNIT	Air bag diagnosis sensor unit is malfunctioning		<a href="#">SRC-50, "DTC Logic"</a> .
B1049 B1054	DRIVER AIRBAG MODULE [OPEN]	Driver air bag module circuit is open (including the spiral cable)		<a href="#">SRC-52, "DTC Logic"</a> .

# DIAGNOSIS SENSOR UNIT

## < ECU DIAGNOSIS INFORMATION >

DTC	Diagnostic item	Explanation	Reference page
B1050 B1055	DRIVER AIRBAG MODULE [VB-SHORT]	Driver air bag module circuit is shorted to power supply circuit (including the spiral cable)	<a href="#">SRC-54, "DTC Logic"</a> .
B1051 B1056	DRIVER AIRBAG MODULE [GND-SHORT]	Driver air bag module circuit is shorted to ground (including the spiral cable)	<a href="#">SRC-56, "DTC Logic"</a> .
B1052 B1057	DRIVER AIRBAG MODULE [SHORT]	Driver air bag module circuits are shorted to each other (including spiral cable)	<a href="#">SRC-58, "DTC Logic"</a> .
B1058-B1063	CONTROL UNIT	Air bag diagnosis sensor unit is malfunctioning	<a href="#">SRC-60, "DTC Logic"</a> .
B1065 B1070	ASSIST A/B MODULE [OPEN]	Passenger air bag module circuit is open	<a href="#">SRC-62, "DTC Logic"</a> .
B1066 B1071	ASSIST A/B MODULE [VB-SHORT]	Passenger air bag module circuit is shorted to power supply circuit	<a href="#">SRC-64, "DTC Logic"</a> .
B1067 B1072	ASSIST A/B MODULE [GND-SHORT]	Passenger air bag module circuit is shorted to ground	<a href="#">SRC-66, "DTC Logic"</a> .
B1068 B1073	ASSIST A/B MODULE [SHORT]	Passenger air bag module circuits are shorted to each other	<a href="#">SRC-68, "DTC Logic"</a> .
B1074-B1079	CONTROL UNIT	Air bag diagnosis sensor unit is malfunctioning	<a href="#">SRC-70, "DTC Logic"</a> .
B1080 B1096	DRIVER AIRBAG MODULE [SHORT]	Driver air bag module circuits are shorted to each other (including spiral cable)	<a href="#">SRC-72, "DTC Logic"</a> .
B1081	PRE-TEN FRONT RH [OPEN]	Seat belt pre-tensioner RH circuit is open	<a href="#">SRC-74, "DTC Logic"</a> .
B1082	PRE-TEN FRONT RH [VB-SHORT]	Seat belt pre-tensioner RH circuit is shorted to power supply circuit	<a href="#">SRC-76, "DTC Logic"</a> .
B1083	PRE-TEN FRONT RH [GND-SHORT]	Seat belt pre-tensioner RH circuit is shorted to ground	<a href="#">SRC-78, "DTC Logic"</a> .
B1084	PRE-TEN FRONT RH [SHORT]	Seat belt pre-tensioner RH circuits are shorted to each other	<a href="#">SRC-80, "DTC Logic"</a> .
B1086	PRE-TEN FRONT LH [OPEN]	Seat belt pre-tensioner LH circuit is open	<a href="#">SRC-82, "DTC Logic"</a> .
B1087	PRE-TEN FRONT LH [VB-SHORT]	Seat belt pre-tensioner LH circuit is shorted to power supply circuit	<a href="#">SRC-84, "DTC Logic"</a> .
B1088	PRE-TEN FRONT LH [GND-SHORT]	Seat belt pre-tensioner LH circuit is shorted to ground	<a href="#">SRC-86, "DTC Logic"</a> .
B1089	PRE-TEN FRONT LH [SHORT]	Seat belt pre-tensioner LH circuits are shorted to each other	<a href="#">SRC-88, "DTC Logic"</a> .
B1090-B1095	CONTROL UNIT	Air bag diagnosis sensor unit is malfunctioning	<a href="#">SRC-90, "DTC Logic"</a> .
B1106-B1111	CONTROL UNIT	Air bag diagnosis sensor unit is malfunctioning	<a href="#">SRC-92, "DTC Logic"</a> .
B1113 B1114	SATELLITE SENS RH [UNIT FAIL]	Satellite sensor RH is malfunctioning	<a href="#">SRC-94, "DTC Logic"</a> .
B1115	SATELLITE SENS RH [COMM FAIL]	Satellite sensor RH is malfunctioning	<a href="#">SRC-96, "DTC Logic"</a> .
B1116	SATELLITE SENS RH [UNMATCH]	Satellite sensor RH is out of the specified specification	<a href="#">SRC-98, "DTC Logic"</a> .
B1118 B1119	SATELLITE SENS LH [UNIT FAIL]	Satellite sensor LH is malfunctioning	<a href="#">SRC-100, "DTC Logic"</a> .
B1120	SATELLITE SENS LH [COMM FAIL]	Satellite sensor RH is malfunctioning	<a href="#">SRC-102, "DTC Logic"</a> .
B1121	SATELLITE SENS LH [UNMATCH]	Satellite sensor RH is out of the specified specification	<a href="#">SRC-104, "DTC Logic"</a> .

A  
B  
C  
D  
E  
F  
G  
I  
J  
K  
L  
M  
N  
O  
P

SBC

## DIAGNOSIS SENSOR UNIT

### < ECU DIAGNOSIS INFORMATION >

DTC	Diagnostic item	Explanation	Reference page
B1122-B1127	CONTROL UNIT	Air bag diagnosis sensor unit is malfunctioning	<a href="#">SRC-106, "DTC Logic"</a> .
B1129	SIDE MODULE RH [OPEN]	Side air bag module RH circuit is open	<a href="#">SRC-108, "DTC Logic"</a> .
B1130	SIDE MODULE RH [VB-SHORT]	Side air bag module RH circuit is shorted to power supply circuit	<a href="#">SRC-110, "DTC Logic"</a> .
B1131	SIDE MODULE RH [GND-SHORT]	Side air bag module RH circuit is shorted to ground	<a href="#">SRC-112, "DTC Logic"</a> .
B1132	SIDE MODULE RH [SHORT]	Seat belt pre-tensioner RH circuits are shorted to each other	<a href="#">SRC-114, "DTC Logic"</a> .
B1134	SIDE MODULE LH [OPEN]	Side air bag module LH circuit is open	<a href="#">SRC-116, "DTC Logic"</a> .
B1135	SIDE MODULE LH [VB-SHORT]	Side air bag module LH circuit is shorted to power supply circuit	<a href="#">SRC-118, "DTC Logic"</a> .
B1136	SIDE MODULE LH [GND-SHORT]	Side air bag module LH circuit is shorted to ground	<a href="#">SRC-120, "DTC Logic"</a> .
B1137	SIDE MODULE LH [SHORT]	Side air bag module LH circuits are shorted to each other	<a href="#">SRC-122, "DTC Logic"</a> .
B1138-B1143	CONTROL UNIT	Air bag diagnosis sensor unit is malfunctioning	<a href="#">SRC-124, "DTC Logic"</a> .
B1144	CONTROL UNIT	Air bag diagnosis sensor unit is malfunctioning or out of the specified specification	<a href="#">SRC-126, "DTC Logic"</a> .
B1145	CURTAIN MODULE RH [OPEN]	Curtain air bag module RH circuit is open	<a href="#">SRC-127, "DTC Logic"</a> .
B1146	CURTAIN MODULE RH [VB-SHORT]	Curtain air bag module RH circuit is shorted to power supply circuit	<a href="#">SRC-129, "DTC Logic"</a> .
B1147	CURTAIN MODULE RH [GND-SHORT]	Curtain air bag module RH circuit is shorted to ground	<a href="#">SRC-131, "DTC Logic"</a> .
B1148	CURTAIN MODULE RH [SHORT]	Curtain air bag module RH circuits are shorted to each other	<a href="#">SRC-133, "DTC Logic"</a> .
B1150	CURTAIN MODULE LH [OPEN]	Curtain air bag module LH circuit is open	<a href="#">SRC-135, "DTC Logic"</a> .
B1151	CURTAIN MODULE LH [VB-SHORT]	Curtain air bag module LH circuit is shorted to power supply circuits	<a href="#">SRC-137, "DTC Logic"</a> .
B1152	CURTAIN MODULE LH [GND-SHORT]	Curtain air bag module LH circuit is shorted to ground	<a href="#">SRC-139, "DTC Logic"</a> .
B1153	CURTAIN MODULE LH [SHORT]	Curtain air bag module LH circuits are shorted to each other	<a href="#">SRC-141, "DTC Logic"</a> .
B1154-B1159	CONTROL UNIT	Air bag diagnosis sensor unit is malfunctioning	<a href="#">SRC-143, "DTC Logic"</a> .
B1170-B1175	CONTROL UNIT	Air bag diagnosis sensor unit is malfunctioning	<a href="#">SRC-145, "DTC Logic"</a> .
B1186-B1191	CONTROL UNIT	Air bag diagnosis sensor unit is malfunctioning	<a href="#">SRC-147, "DTC Logic"</a> .
B1202-B1207	CONTROL UNIT	Air bag diagnosis sensor unit is malfunctioning	<a href="#">SRC-149, "DTC Logic"</a> .
B1209	FRONTAL COLLISION DETECTION	Seat belt pre-tensioner, driver side air bag and passenger air bag are deployed	<a href="#">SRC-151, "DTC Logic"</a> .
B1210	SIDE COLLISION DETECTION	Side air bag and curtain air bag are deployed	<a href="#">SRC-152, "DTC Logic"</a> .
B1211	ROLLOVER DETECTION	Seat belt pre-tensioner side curtain air bag module are deployed because of rollover detection	<a href="#">SRC-153, "DTC Logic"</a> .

## DIAGNOSIS SENSOR UNIT

### < ECU DIAGNOSIS INFORMATION >

DTC	Diagnostic item	Explanation	Reference page
B1212-B1214	RH1 SAT-SENS	Satellite sensor RH is malfunctioning	<a href="#">SRC-154, "DTC Logic"</a> .
B1215-B1217	LH1 SAT-SENS	Satellite sensor LH is malfunctioning	<a href="#">SRC-156, "DTC Logic"</a> .
B1218-B1223	CONTROL UNIT	Air bag diagnosis sensor unit is malfunctioning	<a href="#">SRC-158, "DTC Logic"</a> .
B1239	CONTROL UNIT	Air bag diagnosis sensor unit is malfunctioning	<a href="#">SRC-160, "DTC Logic"</a>
B1257	FR-RH DOOR MNT MODULE [OPEN]	Door mounted curtain air bag RH circuit is open	<a href="#">SRC-161, "DTC Logic"</a>
B1258	FR-RH DOOR MNT MODULE [VB-SHORT]	Door mounted curtain air bag RH circuit is shorted to power supply circuit	<a href="#">SRC-163, "DTC Logic"</a>
B1259	FR-RH DOOR MNT MODULE [GND-SHORT]	Door mounted curtain air bag RH circuit is shorted to ground	<a href="#">SRC-165, "DTC Logic"</a>
B1260	FR-RH DOOR MNT MODULE [SHORT]	Door mounted curtain air bag RH circuit are shorted to each other	<a href="#">SRC-167, "DTC Logic"</a>
B1262	FR-RH DOOR MNT MODULE [OPEN]	Door mounted curtain air bag LH circuit is open	<a href="#">SRC-169, "DTC Logic"</a>
B1263	FR-LH DOOR MNT MODULE [VB-SHORT]	Door mounted curtain air bag LH circuit is shorted to power supply circuit	<a href="#">SRC-171, "DTC Logic"</a>
B1264	FR-LH DOOR MNT MODULE [GND-SHORT]	Door mounted curtain air bag LH circuit is shorted to ground	<a href="#">SRC-173, "DTC Logic"</a>
B1265	FR-LH DOOR MNT MODULE [SHORT]	Door mounted curtain air bag LH circuit are shorted to each other	<a href="#">SRC-175, "DTC Logic"</a>
B1289	RH POP-UP BAR [OPEN]	Pop-up bar RH circuit is open	<a href="#">SRC-177, "DTC Logic"</a>
B1290	RH POP-UP BAR [VB-SHORT]	Pop-up bar RH circuit is shorted to power supply circuit	<a href="#">SRC-179, "DTC Logic"</a>
B1291	RH POP-UP BAR [GND-SHORT]	Pop-up bar RH circuit is shorted to ground	<a href="#">SRC-181, "DTC Logic"</a>
B1292	RH POP-UP BAR [SHORT]	Pop-up bar RH circuit are shorted to each other	<a href="#">SRC-183, "DTC Logic"</a>
B1294	LH POP-UP BAR [OPEN]	Pop-up bar LH circuit is open	<a href="#">SRC-185, "DTC Logic"</a>
B1295	LH POP-UP BAR [VB-SHORT]	Pop-up bar LH circuit is shorted to power supply circuit	<a href="#">SRC-187, "DTC Logic"</a>
B1296	LH POP-UP BAR [GND-SHORT]	Pop-up bar LH circuit is shorted to ground	<a href="#">SRC-189, "DTC Logic"</a>
B1297	LH POP-UP BAR [SHORT]	Pop-up bar LH circuit are shorted to each other	<a href="#">SRC-191, "DTC Logic"</a>
B1298	POP-UP BAR [DEPLOYED]	Pop-up bar is deployed	<a href="#">SRC-193, "DTC Logic"</a>

A  
B  
C  
D  
E  
F  
G  
SBC  
I  
J  
K  
L  
M  
N  
O  
P

# DIAGNOSIS SENSOR UNIT

< ECU DIAGNOSIS INFORMATION >

## Wiring Diagram - SRS AIR BAG CONTROL SYSTEM -

INFOID:000000006965318

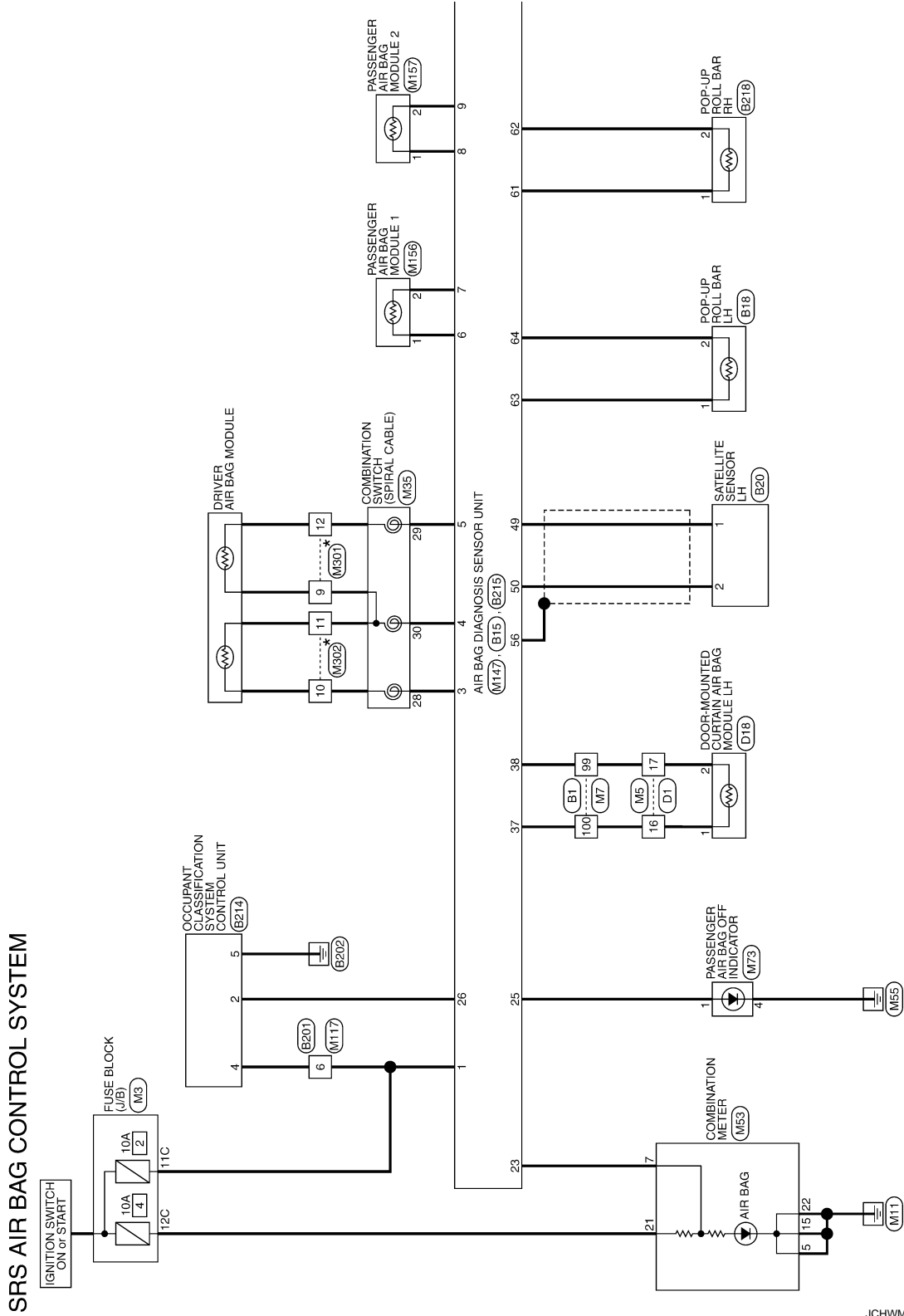

\*: This connector is not shown in "Harness Layout".

2010/10/12

JCHWM0876GB

# DIAGNOSIS SENSOR UNIT

< ECU DIAGNOSIS INFORMATION >

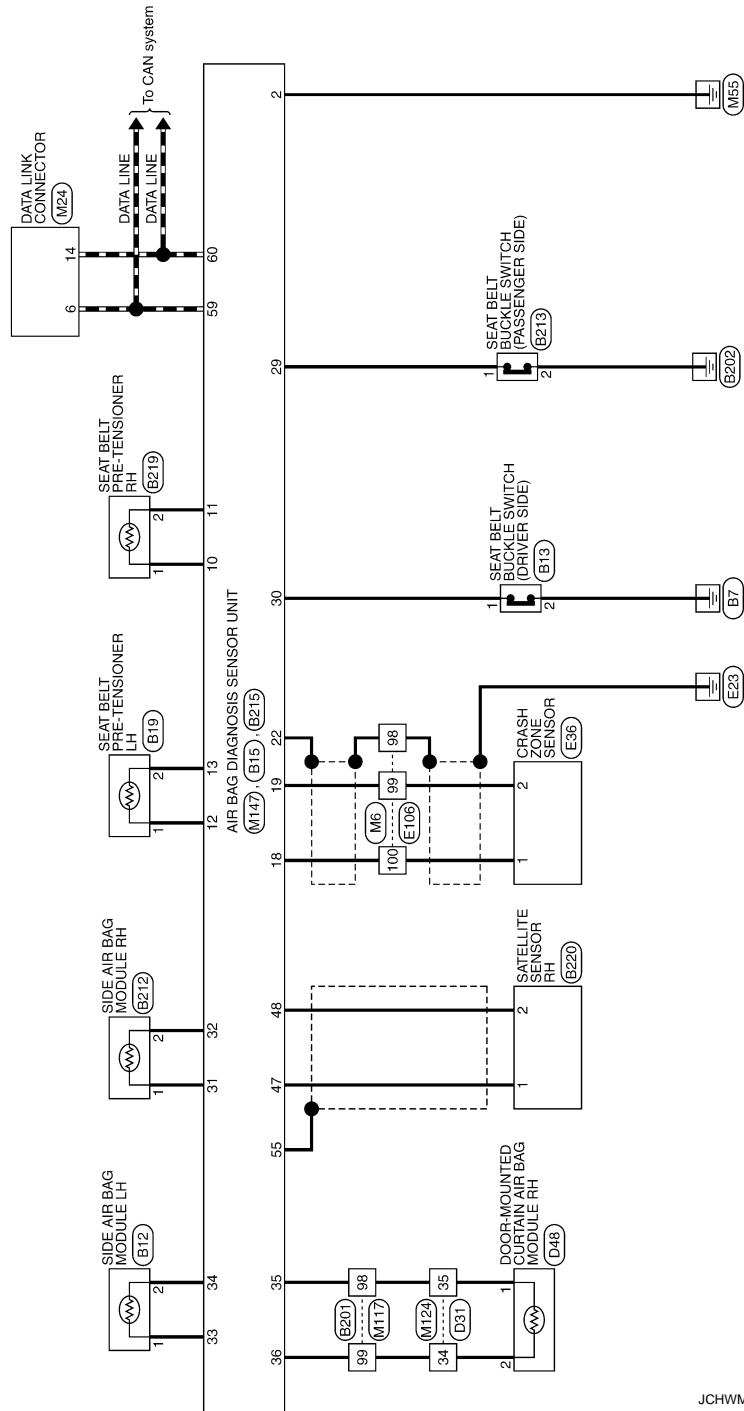

JCHWM0877GB

A  
B  
C  
D  
E  
F  
G  
H  
I  
J  
K  
L  
M  
N  
O  
P

SBC

# DIAGNOSIS SENSOR UNIT

< ECU DIAGNOSIS INFORMATION >

## SRS AIR BAG CONTROL SYSTEM

Connector No.	B1
Connector Name	WIRE TO WIRE
Connector Type	THB07V-CS16-TM44



Terminal No.	Color of Wire	Signal Name [Specification]
1	W	
2	L	
3	R	
4	V	
5	W	
6	B	
8	G	
10	BR	
12	SHIELD	
13	Y	
14	L	
15	R	
16	W	
17	BR	
20	G	
21	SB	
22	GR	
23	W	
24	SB	
25	BR	
26	LG	
27	Y	
28	R	
29	V	
31	SHIELD	
32	G	
33	R	
34	BG	
35	GR	
36	BR	
37	P	- [With climate controlled seat]
37	Y	- [Without climate controlled seat]
38	V	- [With climate controlled seat]
38	GR	- [Without climate controlled seat]
40	SHIELD	
41	L	
42	P	
43	SHIELD	

44	SB	-
45	V	-
46	W	-
47	SB	-
48	LG	-
49	LG	- [With BOSE system]
49	Y	- [Without BOSE system]
50	SB	-
50	LG	- [With BOSE system]
51	SB	- [Without BOSE system]
52	G	-
53	LG	-
54	BR	-
55	Y	-
56	W	-
57	V	-
58	R	-
60	R	-
61	BG	-
62	B	-
63	L	-
64	P	-
65	B	-
66	SB	-
67	P	-
68	L	-
69	P	-
70	L	-
80	G	-
82	R	-
83	BR	-
84	G	-
85	L	-
86	Y	-
87	GR	-
91	R	-
93	BG	-
94	P	-
95	GR	-
96	GR	-
97	SB	-
99	Y	-
100	Y/B	-

Connector No.	B12
Connector Name	SIDE AIR BAG MODULE LH
Connector Type	TK02FY-EX-1V



Terminal No.	Color of Wire	Signal Name [Specification]
1	Y	
2	Y	

Connector No.	B13
Connector Name	SEAT BELT BUCKLE SWITCH (DRIVER SIDE)
Connector Type	A03FW

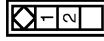

Terminal No.	Color of Wire	Signal Name [Specification]
1	W	
2	B	

Connector No.	B15
Connector Name	AIR BAG DIAGNOSIS SENSOR UNIT
Connector Type	MH2FY-2V-EX

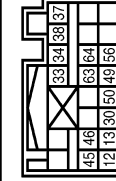

Terminal No.	Color of Wire	Signal Name [Specification]
12	Y	PLH (+)
13	Y	PLH (-)

30	SB	LH BUCKLE SW INPUT
33	Y	SLH (+)
34	Y	SLH (-)
37	Y/B	GLH (+)
38	Y	GLH (-)
49	P	SATELLITE LH (+)
50	L	SATELLITE LH (-)
56	SHIELD	GND
63	Y	ELH (+)
64	Y/B	ELH (-)

Connector No.	B18
Connector Name	POP-UP ROLL BAR LH
Connector Type	TK02FY-EX-1V



Terminal No.	Color of Wire	Signal Name [Specification]
1	Y	
2	Y/B	

Connector No.	B19
Connector Name	SEAT BELT PRE-TENSIONER LH
Connector Type	ACB02FY



Terminal No.	Color of Wire	Signal Name [Specification]
1	Y	
2	Y	

JCHWM00878GB



# DIAGNOSIS SENSOR UNIT

< ECU DIAGNOSIS INFORMATION >

## SRS AIR BAG CONTROL SYSTEM

Connector No.	B20
Connector Name	SATELLITE SENSOR LH
Connector Type	HK02FY-IV-EX-LC



Terminal No.	Color of Wire	Signal Name [Specification]
1	P	-
2	L	-

Connector No.	B201
Connector Name	WIRE TO WIRE
Connector Type	TH08FW-CS16-TM4

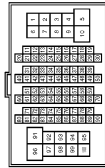

Terminal No.	Color of Wire	Signal Name [Specification]
1	W	-
3	B	-
5	W	-
6	R	-
7	B	- [With climate controlled seat]
7	G	- [Without climate controlled seat]
8	BG	-
9	GR	-
10	LG	-
40	GR	-
41	LG	-
42	BG	-
43	R	-
44	SHIELD	-
45	G	-
47	G	-
48	Y	-
48	SHIELD	-
50	P	-
51	SB	-

52	LG	-
53	L	-
54	G	-
55	GR	-
56	LG	-
57	G	-
58	R	-
67	L	-
68	P	-
80	G	-
81	R	-
82	W	-
83	B	-
84	SHIELD	-
85	O	-
86	BR	-
87	Y	-
88	SHIELD	-
89	SB	-
90	Y	-
91	GR	-
92	P	- [With BOSE system]
92	Y	- [Without BOSE system]
93	L	-
94	SB	-
95	V	-
96	P	-
97	L	- [With BOSE system]
97	LG	- [Without BOSE system]
98	Y/B	-
99	Y	-

Connector No.	B212
Connector Name	SIDE AIR BAG MODULE RH
Connector Type	TK02FY-EX-TV



Terminal No.	Color of Wire	Signal Name [Specification]
1	Y	-
2	Y	-

Connector No.	B213
Connector Name	SEAT BELT BUCKLE SWITCH (PASSENGER SIDE)
Connector Type	A03PFW



Terminal No.	Color of Wire	Signal Name [Specification]
1	LG	-
2	B	-

Connector No.	B214
Connector Name	IGNITION CLASSIFICATION SYSTEM CONTROL UNIT
Connector Type	TH08FW-NH

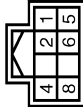

Terminal No.	Color of Wire	Signal Name [Specification]
2	V	COMMUNICATION
4	R	IGN
5	B	GND

Connector No.	B215
Connector Name	AIR BAG DIAGNOSIS SENSOR UNIT
Connector Type	NH02FY-IV-EX



Terminal No.	Color of Wire	Signal Name [Specification]
10	Y	PRH (+)

11	Y	PRH (-)
26	V	ODS INPUT
29	LG	RH BUCKLE SW INPUT
31	Y	-
32	Y	SRH (+)
35	Y/B	GRH (+)
36	Y	GRH (-)
47	G	SATELLITE RH (+)
48	R	SATELLITE RH (-)
55	SHIELD	GND
61	Y	ERH (+)
62	Y/B	ERH (-)

Connector No.	B218
Connector Name	POP-UP ROLL BAR RH
Connector Type	TK02FY-EX-TV



Terminal No.	Color of Wire	Signal Name [Specification]
1	Y	-
2	Y/B	-

Connector No.	B219
Connector Name	SEAT BELT PRE-TENSIONER RH
Connector Type	A03B0FY



Terminal No.	Color of Wire	Signal Name [Specification]
1	Y	-
2	Y	-

A  
B  
C  
D  
E  
F  
G  
H  
I  
J  
K  
L  
M  
N  
O  
P

SBC

JCHWM0879GB

# DIAGNOSIS SENSOR UNIT

< ECU DIAGNOSIS INFORMATION >

## SRS AIR BAG CONTROL SYSTEM

Connector No.	B220
Connector Name	SATELLITE SENSOR RH
Connector Type	HK02FY-IV-EX-LC



Terminal No.	Color of Wire	Signal Name [Specification]
1	G	-
2	R	-

Connector No.	D1
Connector Name	WIRE TO WIRE
Connector Type	TH02FY-CS15



15	14	13	12	11	10	9	8	7	6	5	4	3	2	1
14	13	12	11	10	9	8	7	6	5	4	3	2	1	
13	12	11	10	9	8	7	6	5	4	3	2	1		
12	11	10	9	8	7	6	5	4	3	2	1			
11	10	9	8	7	6	5	4	3	2	1				
10	9	8	7	6	5	4	3	2	1					
9	8	7	6	5	4	3	2	1						
8	7	6	5	4	3	2	1							
7	6	5	4	3	2	1								
6	5	4	3	2	1									
5	4	3	2	1										
4	3	2	1											

Terminal No.	Color of Wire	Signal Name [Specification]
4	BR	-
5	P	- [A/T models with automatic drive positioner]
5	B	- [Except for A/T models with automatic drive positioner]
6	SB	-
7	R	-
8	G	-
9	P	-
10	LG	-
11	W	-
12	L	-
13	B	-
14	V	-
15	Y	-
16	Y/B	-
17	Y	-
20	V	-
21	R	-
22	P	-
23	O	-
24	Y	-

25	SR	-
26	GR	-
27	GR	-
28	LG	-
29	G	-
30	Y	-
31	W	-
32	BR	-
33	L	-
34	R	-
35	V	-
37	B	-
38	O	-
39	GR	-
40	G	-
41	Y	-
42	LG	-
43	BR	-
44	V	-
45	P	-
46	W	-
47	V	-
48	P	-
49	W	-
50	SB	-
51	R	-
52	L	-

Connector No.	D18
Connector Name	DOOR-MOUNTED CURTAIN AIR BAG MODULE LH
Connector Type	ACB02FY



Terminal No.	Color of Wire	Signal Name [Specification]
1	Y/B	-
2	Y	-

Connector No.	D31
Connector Name	WIRE TO WIRE
Connector Type	TH02FY-CS15



15	14	13	12	11	10	9	8	7	6	5	4	3	2	1
14	13	12	11	10	9	8	7	6	5	4	3	2	1	
13	12	11	10	9	8	7	6	5	4	3	2	1		
12	11	10	9	8	7	6	5	4	3	2	1			
11	10	9	8	7	6	5	4	3	2	1				
10	9	8	7	6	5	4	3	2	1					
9	8	7	6	5	4	3	2	1						
8	7	6	5	4	3	2	1							
7	6	5	4	3	2	1								
6	5	4	3	2	1									
5	4	3	2	1										
4	3	2	1											
3	2	1												
2	1													
1														

Terminal No.	Color of Wire	Signal Name [Specification]
6	BR	-
7	R	-
8	G	-
9	P	-
10	LG	-
11	W	-
12	L	-
13	B	-
14	Y	-
15	W	-
34	Y	-
35	Y/B	-
39	O	-
39	GR	-
40	G	-
41	Y	-
42	LG	-
43	BR	-
44	V	-
45	P	-
46	W	-
47	V	-
48	P	-
49	W	-
50	SB	-
51	R	-
54	GR	-
55	G	-

Connector No.	D48
Connector Name	DOOR-MOUNTED CURTAIN AIR BAG MODULE RH
Connector Type	ACB02FY



Terminal No.	Color of Wire	Signal Name [Specification]
1	Y/B	-
2	Y	-

Connector No.	E66
Connector Name	CRASH ZONE SENSOR
Connector Type	HK02FY-IV-EX-LC



Terminal No.	Color of Wire	Signal Name [Specification]
1	P	-
2	L	-

# DIAGNOSIS SENSOR UNIT

< ECU DIAGNOSIS INFORMATION >

## SRS AIR BAG CONTROL SYSTEM

Connector No.	E106
Connector Name	WIRE TO WIRE
Connector Type	TH80PV-CS16-TM4

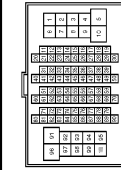

Terminal No.	Color of Wire	Signal Name [Specification]
1	GR	-
3	BG	-
4	B/W	-
5	G	-
6	BG	-
7	LG	-
8	G	-
9	R	-
10	W	-
11	Y	-
12	R	-
13	L	-
14	GR	-
15	P	-
16	W	-
17	V	-
18	BG	-
19	GR	-
20	LG	-
30	R	-
31	L	-
32	BG	-
33	P	-
34	V	-
35	BR	-
36	W	-
37	Y	-
38	R	-
39	B	-
40	G	-
41	W	-
42	LG	-
43	SB	-
44	GR	-
45	BG	-
46	LG	-
47	V	-
48	P	-

49	L	-
59	B	-
66	LG	-
67	SS	-
68	R	-
69	W	-
70	G	-
80	W	-
81	P	-
82	G	-
83	V	-
84	L	-
85	BG	-
86	LG	-
87	Y	-
88	GR	-
89	W	-
90	W	-
91	G	-
92	B	-
93	GR	-
94	L	-
95	Y	-
97	BR	-
98	SHIELD	-
99	L	-
100	P	-

Connector No.	M3
Connector Name	FUSE BLOCK (J/B)
Connector Type	NS12FW-CS

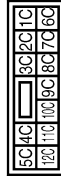

Terminal No.	Color of Wire	Signal Name [Specification]
6C	R	-
7C	B	-
8C	W	-
9C	BG	-
10C	L	-
11C	LG	-
12C	R	-

Connector No.	M5
Connector Name	WIRE TO WIRE
Connector Type	TH80MW-CS15

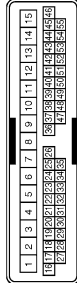

Terminal No.	Color of Wire	Signal Name [Specification]
4	R	-
5	B	-
6	BG	-
7	W	-
8	B	-
9	G	-
10	V	-
11	W	-
12	L	-
13	B	-
14	GR	-
15	Y	-
16	Y/B	-
17	Y	-
20	BG	-
21	W	-
22	P	-
23	BG	-
24	V	-
25	BR	-
26	R	-
27	B	-
28	LG	-
29	SB	-
30	G	-
31	V	-
32	BR	-
33	GR	-
34	G	-
35	L	-
37	B	-
38	G	-
38	L	- [With automatic drive positioner]
38	L	- [Without automatic drive positioner]
39	BR	- [With automatic drive positioner]
39	BR	- [Without automatic drive positioner]
40	Y	-
41	BR	- [With automatic drive positioner]
41	G	- [Without automatic drive positioner]

42	R	-
43	G	-
44	V	-
45	GR	-
46	BR	-
47	V	-
48	LG	-
49	P	-
50	SS	-
51	GR	-
52	L	-

A  
B  
C  
D  
E  
F  
G  
H  
I  
J  
K  
L  
M  
N  
O  
P

SBC

JCHWM0881GB

# DIAGNOSIS SENSOR UNIT

< ECU DIAGNOSIS INFORMATION >

## SRS AIR BAG CONTROL SYSTEM

Connector No.	M6
Connector Name	WIRE TO WIRE
Connector Type	TH80MW-CS16-TM4

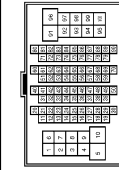

Terminal No.	Color of Wire	Signal Name [Specification]
1	BG	-
2	Y	-
3	R	-
4	G	-
5	G	-
6	BR	-
7	BR	-
8	Y	-
9	R	-
10	W	-
11	GR	-
12	R	-
13	L	-
14	G	-
15	P	-
16	W	-
17	BR	-
18	V	-
19	BG	-
20	L	-
30	R	-
31	L	-
32	Y	-
33	GR	-
34	P	-
35	BR	-
36	BR	-
37	Y	-
38	LG	-
39	SB	-
40	G	-
41	W	-
42	LG	-
43	P	-
44	GR	-
44	R	- [With A/T]
45	BG	-
46	G	-
47	G	-
47	P	- [With M/T]

48	P	-
49	L	-
59	B	-
66	Y	-
67	G	-
68	R	-
69	W	-
70	G	-
80	SB	-
81	R	-
82	V	-
83	W	-
84	L	-
85	BG	-
86	G	-
87	V	-
88	B	-
89	SB	-
90	G	-
91	W	-
92	B	-
93	G	-
94	L	-
95	BR	-
97	P	-
98	SHIELD	-
99	V	-
100	SB	-

Connector No.	M7
Connector Name	WIRE TO WIRE
Connector Type	TH80MW-CS16-TM4

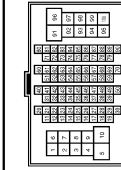

Terminal No.	Color of Wire	Signal Name [Specification]
1	BG	-
2	LG	-
3	G	-
4	V	-
5	L	-
6	B	-
9	L	-
10	BR	-

12	SHIELD	-
13	V	-
14	BR	-
15	GR	-
16	LG	-
17	L	-
20	BR	-
21	G	-
22	R	-
23	SB	-
24	B	-
25	W	-
26	Y	-
27	V	-
28	P	-
29	V	-
31	SHIELD	-
32	G	-
33	R	-
34	BG	-
35	GR	-
36	GR	-
37	P	-
37	L	- [With climate controlled seat]
38	V	- [Without climate controlled seat]
38	GR	- [With climate controlled seat]
40	SHIELD	-
41	L	-
42	P	-
43	SHIELD	-
44	Y	-
45	BR	-
46	SB	-
47	SB	-
48	LG	-
49	LG	-
49	SB	- [With BOSE system]
49	SB	- [Without BOSE system]
50	LG	- [With BOSE system]
50	LG	- [Without BOSE system]
51	R	-
52	V	-
53	P	-
54	BR	-
55	Y	-
55	BG	- [With A/T]
56	L	- [Without M/T]
57	V	-
58	R	-
60	LG	-
61	BG	-
62	B	-
63	V	-

64	SB	-
65	BR	-
66	Y	-
67	P	-
68	L	-
69	P	-
70	L	-
80	G	-
81	LG	-
82	Y	-
83	BR	-
84	V	-
85	L	-
86	Y	-
87	GR	-
91	R	-
93	G	-
94	P	-
95	GR	-
96	Y	-
97	SB	-
99	Y	-
100	Y/B	-

Connector No.	M24
Connector Name	DATA LINK CONNECTOR
Connector Type	BD16FW

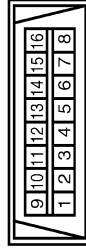

Terminal No.	Color of Wire	Signal Name [Specification]
3	LG	-
4	B	-
5	BR	-
6	L	-
7	V	-
8	G	-
11	SB	-
14	P	-
16	R	-

# DIAGNOSIS SENSOR UNIT

< ECU DIAGNOSIS INFORMATION >

## SRS AIR BAG CONTROL SYSTEM

Connector No.	M35
Connector Name	COMBINATION SWITCH (SPIRAL CABLE)
Connector Type	TK06FY-EX-1V



Terminal No.	Color of Wire	Signal Name [Specification]
23	R	-
28	Y	-
29	Y	-
30	Y	-

Connector No.	M53
Connector Name	COMBINATION METER
Connector Type	SAB40PW



Terminal No.	Color of Wire	Signal Name [Specification]
1	V	BATTERY POWER SUPPLY
2	LG	COMMUNICATION SIGNAL (METER->AMP)
3	GR	COMMUNICATION SIGNAL (AMP->METER)
5	B	GROUND
6	W	ALTERNATOR SIGNAL
7	LG	AIR BAG SIGNAL
10	R	SECURITY SIGNAL
15	B	GROUND
16	B	METER CONTROL SWITCH GROUND
18	GR	ILL GND
19	B	ILL GND
20	R	ILL
21	R	IGNITION SIGNAL
22	B	GROUND
24	SB	COMMUNICATION SIGNAL (LCD->AMP)
25	B	COMMUNICATION SIGNAL (AMP->LCD)
26	R	VEHICLE SPEED SIGNAL (8-PUL SET)
27	V	PARKING BRAKE SWITCH SIGNAL

28	SB	BRAKE FLUID LEVEL SWITCH SIGNAL
29	L	SEAT BELT BUCKLE SW SIGNAL (DRIVER SIDE)
30	G	SEAT BELT BUCKLE SWITCH SIGNAL (PASSENGER SIDE)
31	L	WASHER LEVEL SWITCH SIGNAL
33	R	ILLUMINATION CONTROL SIGNAL
36	LG	SELECT SWITCH SIGNAL
37	SB	ENTER SWITCH SIGNAL
38	L	TRIP A/B RESET SWITCH SIGNAL
39	P	ILLUMINATION CONTROL SWITCH (-)
40	BG	ILLUMINATION CONTROL SWITCH (+)

Connector No.	M73
Connector Name	PASSENGER AIR BAG OFF INDICATOR
Connector Type	TH40MW-NH



Terminal No.	Color of Wire	Signal Name [Specification]
1	R	-
4	B	-

Connector No.	M117
Connector Name	WIRE TO WIRE
Connector Type	TH80MW-CS(θ-TM4)

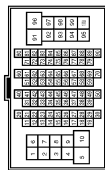

Terminal No.	Color of Wire	Signal Name [Specification]
1	Y	-
3	B	-
5	SB	-
6	R	-
7	G	-
8	SB	-
9	GR	-
10	LG	-

Connector No.	M124
Connector Name	WIRE TO WIRE
Connector Type	TH40MP-CS15

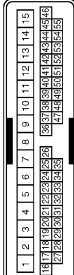

Terminal No.	Color of Wire	Signal Name [Specification]
6	BG	-
7	R	-
8	G	-
9	P	-
10	V	-
11	SB	- [With BOSE system]
11	GR	- [Without BOSE system]
12	BR	-
13	B	-
14	G	-
15	W	-
34	Y	-
35	Y/B	-
38	W	-
39	BG	-
40	SB	-
41	G	- [With automatic drive positioner]
42	R	- [Without automatic drive positioner]
43	L	-
44	Y	-
45	R	-
46	W	-
47	SB	-
48	BR	-
49	Y	-
50	P	-
51	LG	-
52	BG	-
53	Y	-
54	L	-
55	L	-

40	Y	-
41	G	-
42	LG	-
43	R	-
44	SHIELD	-
45	G	-
47	P	-
48	L	-
49	SHIELD	-
50	V	-
51	SB	-
52	BG	-
53	L	-
54	G	-
55	Y	-
56	LG	-
57	SB	-
58	LG	-
67	SB	-
68	LG	-
80	W	-
81	B	-
82	R	-
83	G	-
84	SHIELD	-
85	G	-
86	L	-
87	P	-
88	SHIELD	-
89	Y	-
90	W	-
91	GR	-
92	P	-
93	W	-
94	BG	-
95	BG	-
96	P	-
97	L	-
98	Y/B	-
99	Y	-

A  
B  
C  
D  
E  
F  
G  
H  
I  
J  
K  
L  
M  
N  
O  
P

SBC

JCHWM0883GB

# DIAGNOSIS SENSOR UNIT

< ECU DIAGNOSIS INFORMATION >

## SRS AIR BAG CONTROL SYSTEM

Connector No.	M147
Connector Name	AIR BAG DIAGNOSIS SENSOR UNIT
Connector Type	1N2BFY-EX

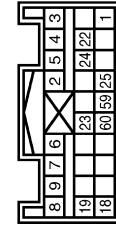

Terminal No.	Color of Wire	Signal Name [Specification]
1	LG	IGN
2	B	GND
3	Y	DRI (+)
4	Y	DRI (-)
5	Y	DR2 (+)
6	Y	AS1 (+)
7	Y	AS1 (-)
8	Y	AS2 (+)
9	Y	AS2 (-)
18	SB	ECZS (+)
19	Y	ECZS (-)
22	SHIELD	GND
23	LG	AIRBAG W/L
24	G	SEAT BELT
25	R	CUTOFF TELLTALE
59	L	CAN-H
60	P	CAN-L

Connector No.	M156
Connector Name	PASSENGER AIR BAG MODULE 1
Connector Type	JCA0ZFE



Terminal No.	Color of Wire	Signal Name [Specification]
1	Y	-
2	Y	-

Connector No.	M157
Connector Name	PASSENGER AIR BAG MODULE 2
Connector Type	JCA0ZFOR



Terminal No.	Color of Wire	Signal Name [Specification]
1	Y	-
2	Y	-

Connector No.	M301
Connector Name	DRIVER AIR BAG MODULE
Connector Type	JCA0ZFOR



Terminal No.	Color of Wire	Signal Name [Specification]
9	-	-
12	-	-

Connector No.	M302
Connector Name	DRIVER AIR BAG MODULE
Connector Type	JCA0ZFY-2V



Terminal No.	Color of Wire	Signal Name [Specification]
10	-	-
11	-	-

JCHWM0884GB

# SEAT BELT WARNING LAMP DOES NOT TURN OFF

< SYMPTOM DIAGNOSIS >

## SYMPTOM DIAGNOSIS

### SEAT BELT WARNING LAMP DOES NOT TURN OFF

#### Diagnosis Procedure

INFOID:000000006471735

#### 1. CHECK SEAT BELT BUCKLE SWITCH (DRIVER SIDE)

Check seat belt buckle switch (driver side). Refer to [SBC-23, "DRIVER SIDE : Component Function Check"](#)

Is the inspection result normal?

YES >> GO TO 2.

NO >> Repair or replace the malfunctioning parts.

#### 2. CHECK SEAT BELT BUCKLE SWITCH (PASSENGER SIDE)

Check seat belt buckle switch (passenger side). Refer to [SBC-24, "PASSENGER SIDE : Component Function Check"](#)

Is the inspection result normal?

YES >> GO TO 3.

NO >> Repair or replace the malfunctioning parts.

#### 3. CHECK SEAT BELT WARNING LAMP CIRCUIT

Check seat belt warning lamp circuit. Refer to [SBC-28, "Diagnosis Procedure"](#)

Is the inspection result normal?

YES >> GO TO 4.

NO >> Repair or replace the malfunctioning parts.

#### 4. CONFIRM THE OPERATION

Confirm the operation again.

Is the inspection result normal?

YES >> Check intermittent incident. Refer to [GI-43, "Intermittent Incident"](#).

NO >> GO TO 1.

A  
B  
C  
D  
E  
F  
G  
I  
J  
K  
L  
M  
N  
O  
P

SBC

# SEAT BELT WARNING LAMP DOES NOT TURN ON

< SYMPTOM DIAGNOSIS >

---

## SEAT BELT WARNING LAMP DOES NOT TURN ON

### Diagnosis Procedure

INFOID:000000006471736

#### 1. CHECK SELF-DIAGNOSIS RESULT

---

Perform "COMBINATION METER" self-diagnostic result. Refer to [MWI-81, "DTC Index"](#)

Is DTC detected?

- YES >> Repair or replace the malfunctioning parts.
- NO >> GO TO 2.

#### 2. CHECK POWER SUPPLY

---

Check that fuses are not blown.

Check ignition power supply of combination meter. Refer to [SBC-27, "Diagnosis Procedure"](#)

Is the inspection result normal?

- YES >> GO TO 3.
- NO >> Repair or replace the malfunctioning parts.

#### 3. CHECK SEAT BELT BUCKLE SWITCH (DRIVER SIDE)

---

Check seat belt buckle switch (driver side). Refer to [SBC-23, "DRIVER SIDE : Component Function Check"](#)

Is the inspection result normal?

- YES >> GO TO 4.
- NO >> Repair or replace the malfunctioning parts.

#### 4. CHECK SEAT BELT BUCKLE SWITCH (PASSENGER SIDE)

---

Check seat belt buckle switch (passenger side). Refer to [SBC-24, "PASSENGER SIDE : Component Function Check"](#)

Is the inspection result normal?

- YES >> GO TO 5.
- NO >> Repair or replace the malfunctioning parts.

#### 5. CHECK SEAT BELT WARNING LAMP CIRCUIT

---

Check seat belt warning lamp circuit. Refer to [SBC-28, "Diagnosis Procedure"](#)

Is the inspection result normal?

- YES >> GO TO 6.
- NO >> Repair or replace the malfunctioning parts.

#### 6. CONFIRM THE OPERATION

---

Confirm the operation again.

Is the inspection result normal?

- YES >> Check intermittent incident. Refer to [GI-43, "Intermittent Incident"](#).
- NO >> GO TO 1.



# PRE-CRASH SEAT BELT DOES NOT OPERATE

< SYMPTOM DIAGNOSIS >

## PRE-CRASH SEAT BELT DOES NOT OPERATE BOTH SIDES

BOTH SIDES : Diagnosis Procedure

INFOID:000000006471737

### 1.CHECK POWER SUPPLY AND GROUND CIRCUIT

Check power supply and ground circuit. Refer to [SBC-27. "Diagnosis Procedure"](#)

Is the inspection result normal?

YES >> GO TO 2.

NO >> Repair or replace the malfunctioning parts.

### 2.CONFIRM THE OPERATION

Confirm the operation again.

Is the inspection result normal?

YES >> Check intermittent incident. Refer to [GI-43. "Intermittent Incident"](#).

NO >> GO TO 1.

## DRIVER SIDE

DRIVER SIDE : Diagnosis Procedure

INFOID:000000006471738

### 1.CHECK SEAT BELT BUCKLE SWITCH (DRIVER SIDE)

Check seat belt buckle switch (driver side). Refer to [SBC-23. "DRIVER SIDE : Component Function Check"](#)

Is the inspection result normal?

YES >> GO TO 2.

NO >> Repair or replace the malfunctioning parts.

### 2.CONFIRM THE OPERATION

Confirm the operation again.

Is the inspection result normal?

YES >> Check intermittent incident. Refer to [GI-43. "Intermittent Incident"](#).

NO >> GO TO 1.

## PASSENGER SIDE

PASSENGER SIDE : Diagnosis Procedure

INFOID:000000006471739

### 1.CHECK SEAT BELT BUCKLE SWITCH (PASSENGER SIDE)

Check seat belt buckle switch (passenger side). Refer to [SBC-24. "PASSENGER SIDE : Component Function Check"](#)

Is the inspection result normal?

YES >> GO TO 2.

NO >> Repair or replace the malfunctioning parts.

### 2.CONFIRM THE OPERATION

Confirm the operation again.

Is the inspection result normal?

YES >> Check intermittent incident. Refer to [GI-43. "Intermittent Incident"](#).

NO >> GO TO 1.

A  
B  
C  
D  
E  
F  
G  
I  
J  
K  
L  
M  
N  
O  
P

SBC

# PRECAUTIONS

< PRECAUTION >

## PRECAUTION

### PRECAUTIONS

#### Precaution for Supplemental Restraint System (SRS) "AIR BAG" and "SEAT BELT PRE-TENSIONER"

INFOID:000000006471740

The Supplemental Restraint System such as "AIR BAG" and "SEAT BELT PRE-TENSIONER", used along with a front seat belt, helps to reduce the risk or severity of injury to the driver and front passenger for certain types of collision. This system includes seat belt switch inputs and dual stage front air bag modules. The SRS system uses the seat belt switches to determine the front air bag deployment, and may only deploy one front air bag, depending on the severity of a collision and whether the front occupants are belted or unbelted. Information necessary to service the system safely is included in the "SRS AIR BAG" and "SEAT BELT" of this Service Manual.

#### **WARNING:**

Always observe the following items for preventing accidental activation.

- To avoid rendering the SRS inoperative, which could increase the risk of personal injury or death in the event of a collision that would result in air bag inflation, all maintenance must be performed by an authorized NISSAN/INFINITI dealer.
- Improper maintenance, including incorrect removal and installation of the SRS, can lead to personal injury caused by unintentional activation of the system. For removal of Spiral Cable and Air Bag Module, see "SRS AIR BAG".
- Never use electrical test equipment on any circuit related to the SRS unless instructed to in this Service Manual. SRS wiring harnesses can be identified by yellow and/or orange harnesses or harness connectors.

#### PRECAUTIONS WHEN USING POWER TOOLS (AIR OR ELECTRIC) AND HAMMERS

#### **WARNING:**

Always observe the following items for preventing accidental activation.

- When working near the Air Bag Diagnosis Sensor Unit or other Air Bag System sensors with the ignition ON or engine running, never use air or electric power tools or strike near the sensor(s) with a hammer. Heavy vibration could activate the sensor(s) and deploy the air bag(s), possibly causing serious injury.
- When using air or electric power tools or hammers, always switch the ignition OFF, disconnect the battery, and wait at least 3 minutes before performing any service.

#### Service Procedure Precautions for Models with a Pop-up Roll Bar

INFOID:000000006471741

#### **WARNING:**

Always observe the following items for preventing accidental activation.

- Risk of passenger injury or death may increase if the pop-up roll bar does not deploy during a roll over collision. In order to reduce the chance of an incident where the pop-up roll bar is inoperative, all maintenance must be performed by a NISSAN or INFINITI dealer.
- Before removing and installing the pop-up roll bar component parts and harness, always turn the ignition switch OFF, disconnect the battery negative terminal, and wait for 3 minutes or more. (The purpose of this operation is to discharge electricity that is accumulated in the auxiliary power supply circuit in the air bag diagnosis sensor unit.)
- When repairing, removing, and installing a pop-up roll bar, always refer to SRS AIR BAG and SRS AIR BAG CONTROL warnings in the Service Manual.

#### Precaution for Battery Service

INFOID:000000006471742

Before disconnecting the battery, lower both the driver and passenger windows. This will prevent any interference between the window edge and the vehicle when the door is opened/closed. During normal operation, the window slightly raises and lowers automatically to prevent any window to vehicle interference. The automatic window function will not work with the battery disconnected.

# PRE-INSPECTION FOR DIAGNOSTIC

< PERIODIC MAINTENANCE >

## PERIODIC MAINTENANCE

### PRE-INSPECTION FOR DIAGNOSTIC

Description

INFOID:000000006471743

**WARNING:**

- The following tests should be performed in a safe, open place that is free of traffic and obstacles.
  - The tests should be performed on a dry, paved road. Never attempt to perform the tests on a wet or unpaved road, open road, or highway. (This may cause an accident or personal injury.)
  - Driver and passenger should assume seat belt may operate and prepare themselves accordingly.
1. Fasten driver and passenger seat belts.
  2. Drive at approximately 25 km/h (16 MPH).
  3. Notify passenger of a sudden stop. Driver and passenger prepare themselves for the possibility of system not operating. Then, driver fully depresses the brake pedal to stop suddenly.
  4. Check that the shoulder of the seat belt is pulled while braking.

A  
B  
C  
D  
E  
F  
G  
I  
J  
K  
L  
M  
N  
O  
P

SBC

# BRAKE PEDAL STROKE SENSOR

< REMOVAL AND INSTALLATION >

## REMOVAL AND INSTALLATION

### BRAKE PEDAL STROKE SENSOR

Exploded View

INFOID:000000006471744

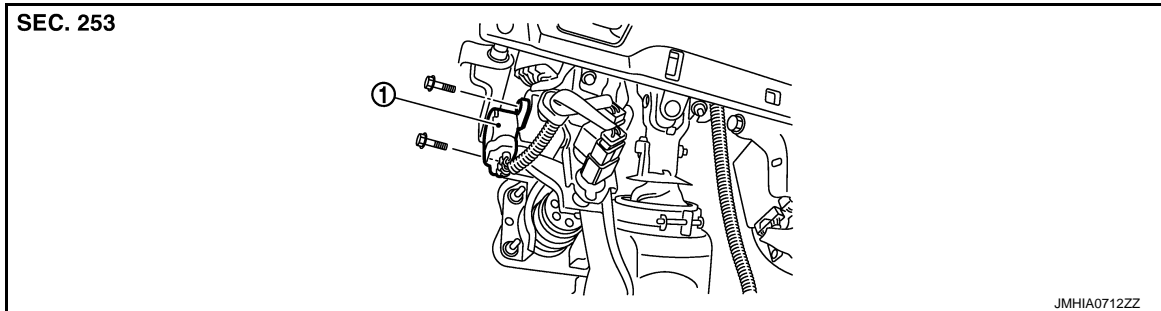

1. Brake pedal stroke sensor

### Removal and Installation

INFOID:000000006471745

#### REMOVAL

1. Remove the instrument panel lower cover LH. Refer to [IP-13, "A/T MODELS : Removal and Installation"](#) (A/T models) or [IP-24, "M/T MODELS : Removal and Installation"](#) (M/T models).
2. Disconnect the brake pedal stroke sensor connector.
3. Remove the screws (A).
4. Remove the brake pedal stroke sensor (1).

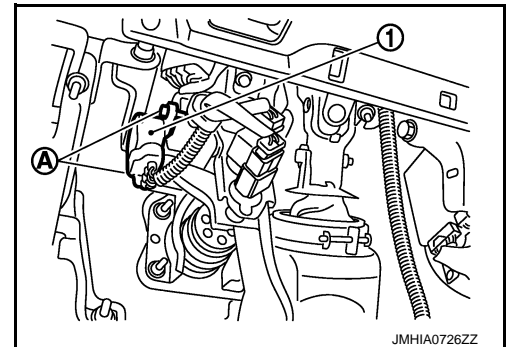

#### INSTALLATION

Install in the reverse order of removal.

# PRE-CRASH SEAT BELT CONTROL UNIT

< REMOVAL AND INSTALLATION >

## PRE-CRASH SEAT BELT CONTROL UNIT

Exploded View

INFOID:000000006471746

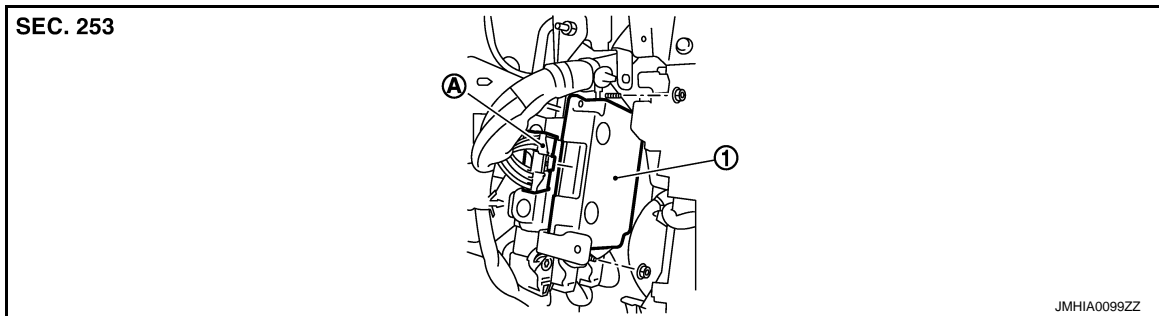

- 1. Pre-crash seat belt control unit
- A. Pre-crash seat belt control unit connector

## Removal and Installation

INFOID:000000006471747

### REMOVAL

1. Remove the glove box. Refer to [IP-13. "A/T MODELS : Removal and Installation"](#) (A/T models) or [IP-24. "M/T MODELS : Removal and Installation"](#) (M/T models).
2. Disconnect the pre-crash seat belt control unit connector (A).
3. Remove the screws.
4. Remove the pre-crash seat belt control unit (1).

### INSTALLATION

Install in the reverse order of removal.

A  
B  
C  
D  
E  
F  
G  
I  
J  
K  
L  
M  
N  
O  
P

SBC